



MONTÁŽNÍ
KONSTRUKCE

PRO FOTOVOLTAIKU

KATALOG VÝROBKU | 2024



ISO 9001
EN ISO 1090
EN ISO 3834 2

📍 **W&H Sp. z o.o.**

ul. Kościuszki 49,
44-351 Turza Śląska,
Polsko

☎ +48 794 730 721

+48 575 530 721

+48 794 930 721

✉ biuro@hetmaniok.pl

🖱 hetmaniok.pl

KATALOG VÝROBKŮ

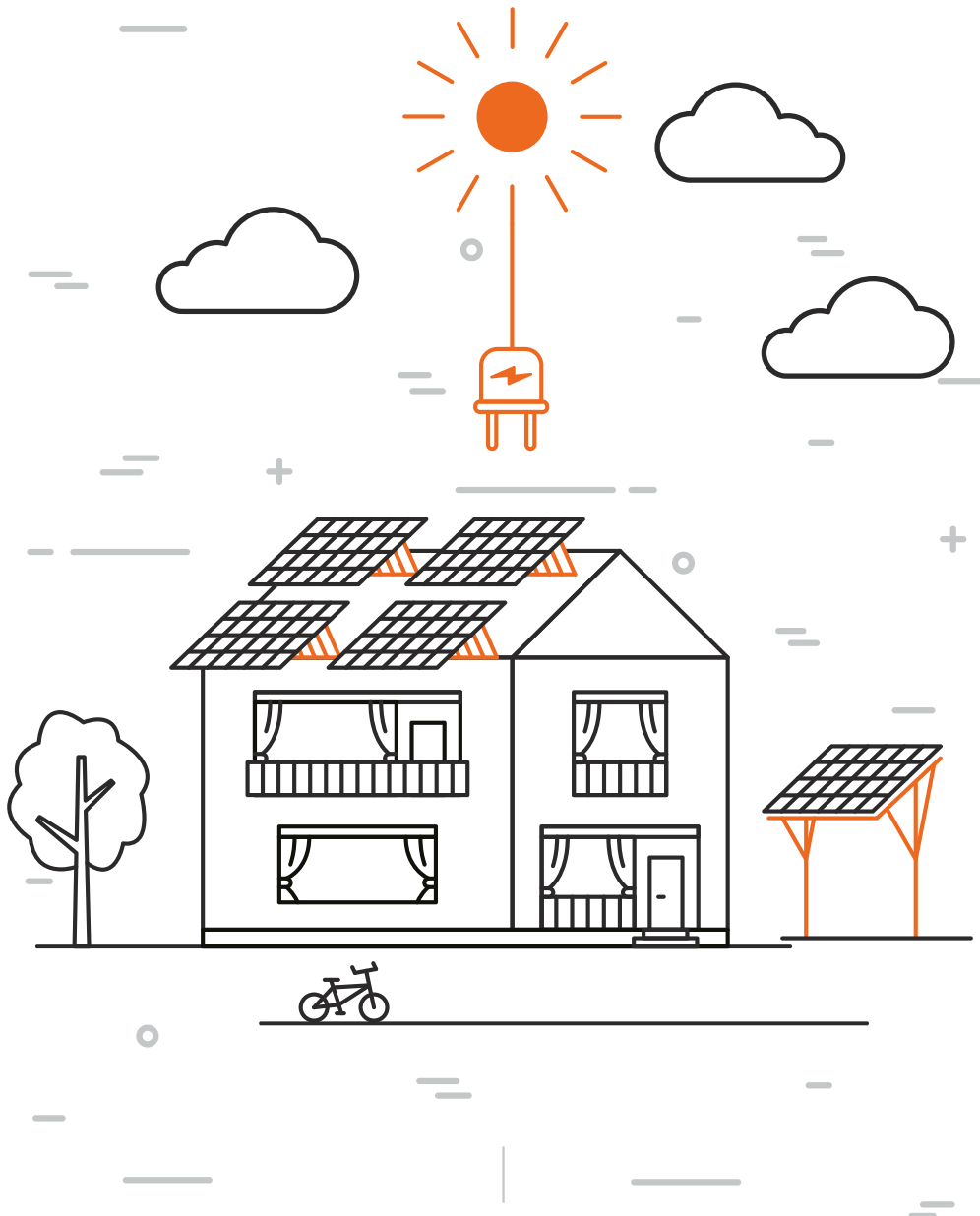

MONTÁŽNÍ KONSTRUKCE
PRO FOTOVOLTAIKU

W&H Sp. z o. o.

KONSTRUKCE NA ŠIKMOU STŘECHU

► Počet modulů: od 2
Certifikát TÜV



PLECH S DRÁŽKOU



TRAPÉZOVÝ PLECH



TRAPÉZOVÝ PLECH, KLIK SYSTÉM, VODOROVNÝ

Střechou, s níž se v Polsku setkáváme nejčastěji, je šikmá střecha. Fotovoltaické panely je možné namontovat i na střechu tohoto typu. Základem takové instalace je odpovídající konstrukce, zejména pak řešení, které umožní efektivní upevnění v závislosti na střešní krytině.



TRAPÉZOVÝ PLECH, KLIK SYSTÉM, SVISLÝ



BITUMENOVÁ STŘEŠNÍ KRYTINA



BITUMENOVÁ STŘEŠNÍ KRYTINA, DVOUZÁVIT



KERAMICKÁ/BETONOVÁ STŘEŠNÍ KRYTINA



PLOCHÁ STŘEŠNÍ KRYTINA



PLECHOVÁ STŘEŠNÍ KRYTINA, NASTAVITELNÝ DRŽÁK



PLECHOVÁ STŘEŠNÍ KRYTINA „JANOŠÍK“, NASTAVITELNÝ DRŽÁK



PLECHOVÁ STŘEŠNÍ KRYTINA, DVOUZÁVIT

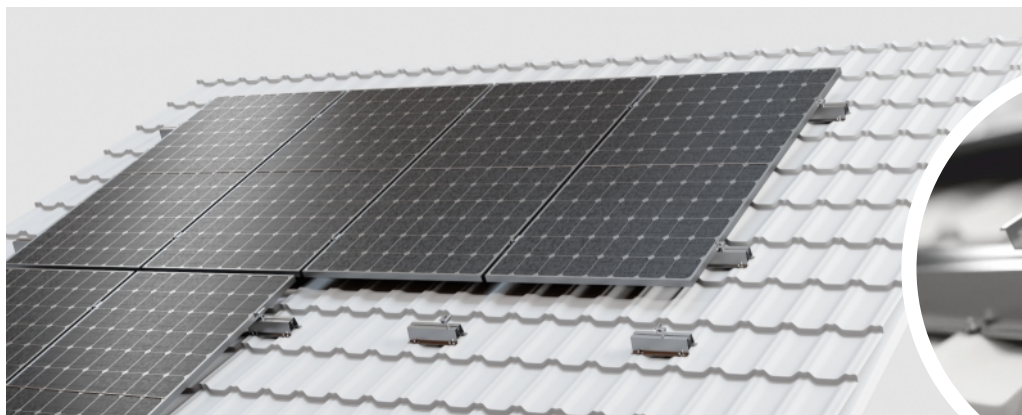

PLECHOVÁ STŘEŠNÍ KRYTINA, KONSTRUKCE NA MŮSTEK

W&H Sp. z o. o.

KONSTRUKCE NA PLOCHOU STŘECHU

▶ Počet modulů: od 1
▶ Certifikát TÜV



Fotovoltaické instalace montované na plochou střechu vyžadují použití konstrukcí, které umožní dosažení optimálního úhlu dopadu slunečních paprsků vůči fotovoltaickým článkům.

V naší nabídce jsme připravili systémy, které se montují:

- na nízkou a vysokou podpěru,
- na hliníkové trojúhelníky, které umožňují invazivní i neinvazivní upevnění.



**SAMOZÁTĚŽOVÁ KONSTRUKCE
AERO JIH**

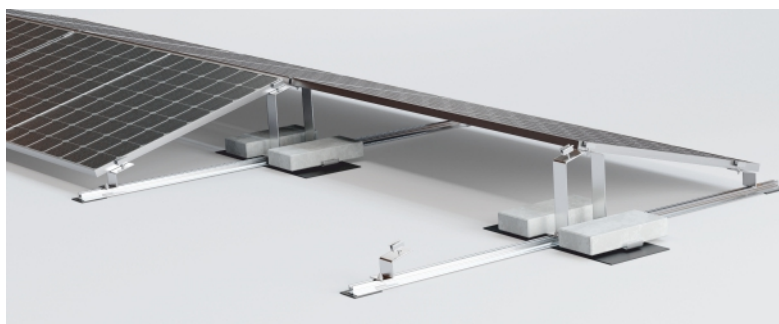

**SAMOZÁTĚŽOVÁ KONSTRUKCE
AERO VÝCHOD-ZÁPAD**



**ZATÍŽENÁ KONSTRUKCE
AERO JIH**





**SAMOZÁTĚŽOVÁ ZATÍŽENÁ
KONSTRUKCE VÝCHOD-ZÁPAD**



LEPENÁ KONSTRUKCE - VZPĚRY



**PODPĚRNÁ KONSTRUKCE
NA LIŠTÁCH AERO**

KONSTRUKCE NA PLOCHOU STŘECHU

TROJHRAN MAGNELIS

- ▶ Počet modulů: od 1
- ▶ Certifikát TÜV



**JIH 15/20°
LEPENÁ NA LEPENKU/MEMBRÁNU**



**JIH 15/20°
DVOUZÁVITOVÝ ŠROUB**

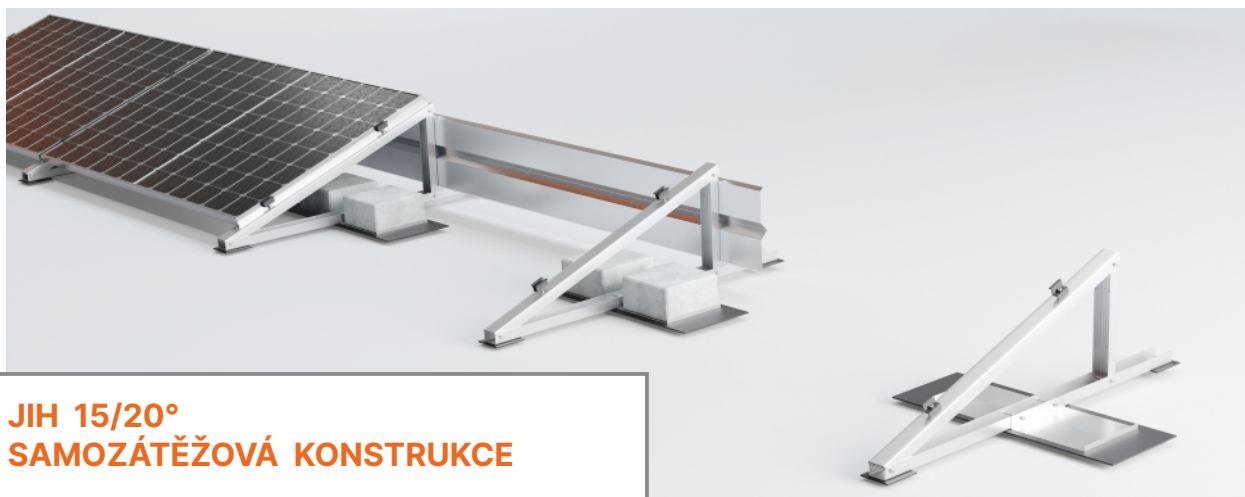

**JIH 15/20°
SAMOZÁTĚŽOVÁ KONSTRUKCE**



**JIH 15/20°
NA SENDVIČOVÝ PANEL**



**JIH 15/20° BIFACIAL
NA SENDVIČOVÝ PANEL**

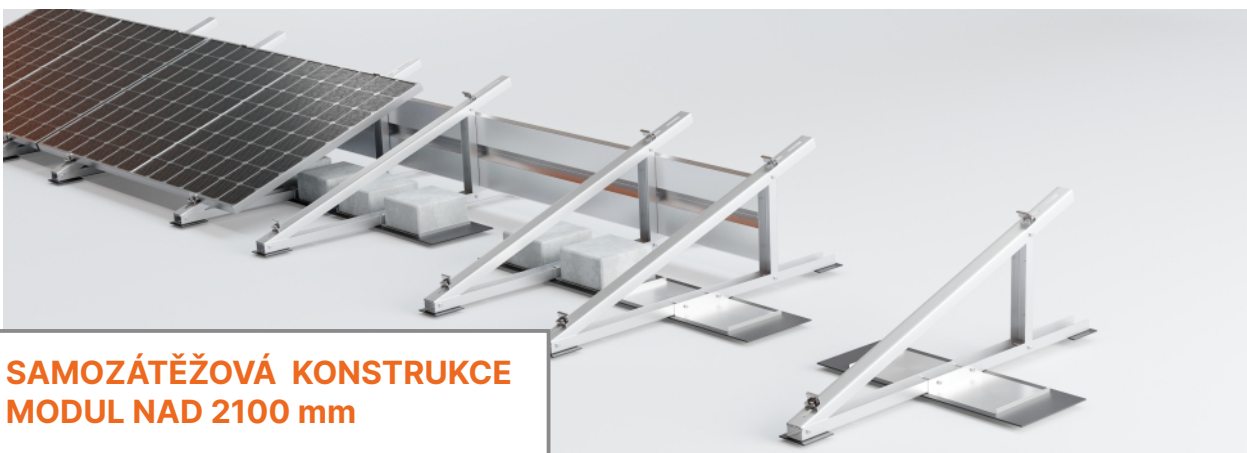

**SAMOZÁTĚŽOVÁ KONSTRUKCE
MODUL NAD 2100 mm**



**LEPENÁ KONSTRUKCE
MODUL NAD 2100 mm**



**LEPENÁ KONSTRUKCE
TROJHRAN MAGNELIS ŠIROKÝ**



**SAMOZÁTĚŽOVÁ KONSTRUKCE
TROJHRAN MAGNELIS ŠIROKÝ**



**KONSTRUKCE NA LIŠTÁCH AERO
TROJHRAN MAGNELIS ŠIROKÝ**



**KONSTRUKCE NA LIŠTÁCH AERO
MODUL NAD 2100 mm**



KONSTRUKCE NA PLOCHOU STŘECHU

TROJHRAN MAGNELIS

- ▶ Počet modulů: od 2
- ▶ Certifikát TÜV

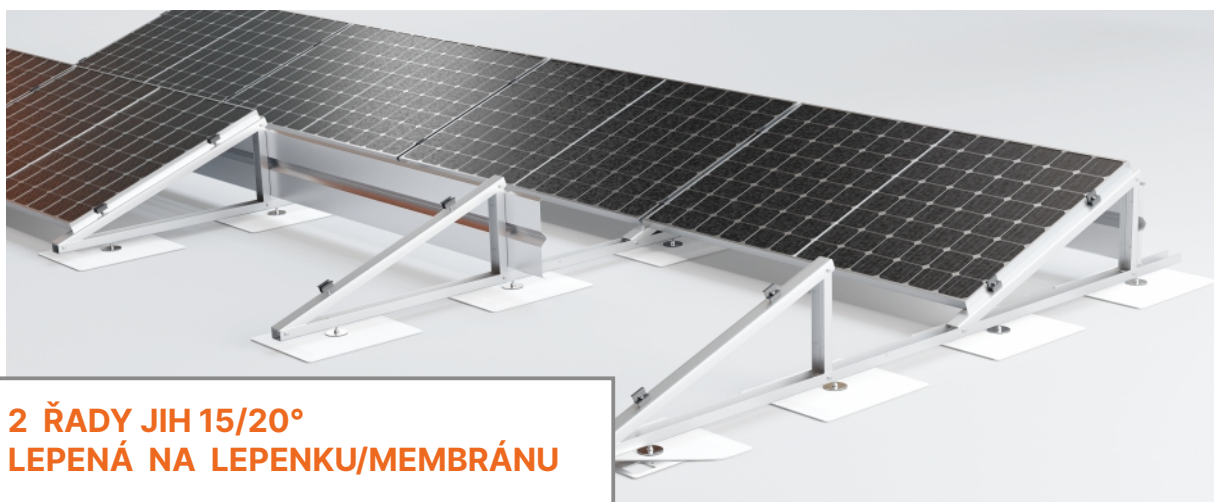

**2 ŘADY JIH 15/20°
LEPENÁ NA LEPENKU/MEMBRÁNU**



**2 ŘADY JIH 15/20°
DVOUZÁVITOVÝ ŠROUB**



**2 ŘADY JIH 15/20°
SAMOZÁTĚŽOVÁ KONSTRUKCE**

KONSTRUKCE NA PLOCHOU STŘECHU

TROJHRAN MAGNELIS

- ▶ Počet modulů: od 2
- ▶ Certifikát TÜV



**VÝCHOD-ZÁPAD
LEPENÁ NA LEPENKU/MEMBRÁNU**



**VÝCHOD-ZÁPAD
DVOUZÁVITOVÝ ŠROUB**

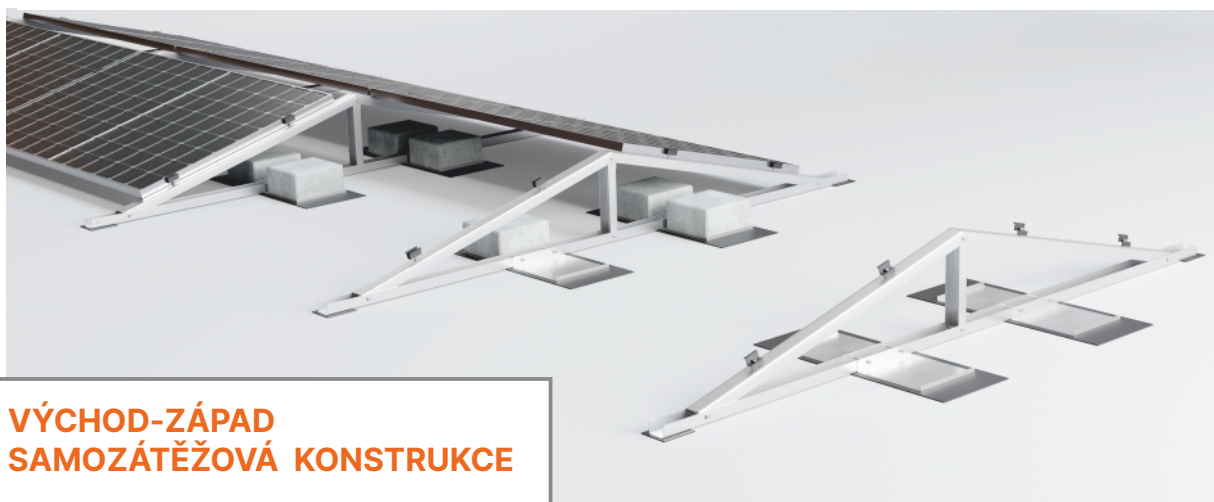

**VÝCHOD-ZÁPAD
SAMOZÁTĚŽOVÁ KONSTRUKCE**



**KONSTRUKCE ROVNOBĚŽNÁ
SE STŘECHOU, ŠROUB S PŘÍTLAKEM**



**BALKONOVÁ KONSTRUKCE,
TROJHRAN MAGNELIS 15°**



**FOTOVOLTAICKÝ PLOT
1 PANEL SVISLE BIFACIAL**



**FOTOVOLTAICKÝ PLOT
2 PANELY VODOROVNĚ BIFACIAL**

**VOLNĚ STOJÍCÍ
KONSTRUKCE**

NA DVOU PODPĚRÁCH



**OCELOVÁ
KONSTRUKCE/MAGNELIS**



**2 PANELY
SVISLE**

- ▶ Počet modulů: od 2
- ▶ Certifikát TÜV



**4 PANELY
VODOROVNĚ**

- ▶ Počet modulů: od 4
- ▶ Certifikát TÜV

Volně stojící konstrukce vyžadují vzhledem k usazení na zemi zvláštní propracování všech součástí. Podle potřeby jsou k dispozici konstrukce s jednou i s dvěma podpěrami.



**OCELOVÁ
KONSTRUKCE/HLINÍK**



**2 PANELY
SVISLE**

- ▶ Počet modulů: od 2
- ▶ Certifikát TÜV



**3 PANELY
VODOROVNĚ**

- ▶ Počet modulů: od 3
- ▶ Certifikát TÜV



**4 PANELY
VODOROVNĚ**

- ▶ Počet modulů: od 4
- ▶ Certifikát TÜV



**5 PANELŮ
VODOROVNĚ**

- ▶ Počet modulů: od 5
- ▶ Certifikát TÜV

Volně stojící konstrukce vyžadují vzhledem k usazení na zemi zvláštní propracování všech součástí. Podle potřeby jsou k dispozici konstrukce s jednou i s dvěma podpěrami.



**OCELOVÁ
KONSTRUKCE/MAGNELIS**



**2 PANELY
SVISLE
BIFACIAL**

- ▶ Počet modulů: od 2
- ▶ Certifikát TÜV



**3 PANELY
VODOROVNĚ**

- ▶ Počet modulů: od 3
- ▶ Certifikát TÜV



**3 PANELY
VODOROVNĚ
BIFACIAL**

- ▶ Počet modulů: od 3
- ▶ Certifikát TÜV



**4 PANELY
VODOROVNĚ
BIFACIAL**

- ▶ Počet modulů: od 4
- ▶ Certifikát TÜV

**VOLNĚ STOJÍCÍ
KONSTRUKCE**

S JEDNOU PODPĚROU



**OCELOVÁ
KONSTRUKCE/HLINÍK**



**2 PANELY
SVISLE**

- ▶ Počet modulů: od 2
- ▶ Certifikát TÜV



**3 PANELY
VODOROVNĚ**

- ▶ Počet modulů: od 3
- ▶ Certifikát TÜV

**VOLNĚ STOJÍCÍ
KONSTRUKCE**

CARPORT



**HLINÍKOVÁ
KONSTRUKCE**

pro moduly > 25 kg

**OCELOVÁ
KONSTRUKCE**



HLINÍKOVÁ
NEBO OCELOVÁ
KONSTRUKCE



MODULOVÝ
SYSTÉM
POJOVÁNÍ



LIBOVOLNÁ
BARVA Z PALETY
RAL

V naší nabídce naleznete hliníkové a ocelové carporty se stáním pro jedno nebo dvě vozidla s možností modulového spojování.

Velikost carportu s jedním stáním je 2,5 m na šířku (dle aktuálních požadavků).

Je možné provést carport podle individuálních požadavků zákazníka včetně nátěru libovolnou barvou z palety RAL.

SOUČÁSTI MONTÁŽNÍCH KONSTRUKCÍ

Jako výrobce montážních konstrukcí nabízíme osvědčená řešení pro každý typ střechy s libovolným typem střešní krytiny. Sázíme na kvalitu a trvanlivost všech konstrukčních součástí.

W&H Sp. z o. o.

ŠROUB IMBUS



- ▶ M8x20
- ▶ M8x25
- ▶ M8x30
- ▶ M8x35

W&H Sp. z o. o.

ŠROUB S ŠESTIHRANNOU HLAVOU



- ▶ M10x25

W&H Sp. z o. o.

ŠROUB S Kladívkovou HLAVOU



- ▶ M10x25
- ▶ M10x30

W&H Sp. z o. o.

VRATOVÝ ŠROUB



- ▶ M10x25

W&H Sp. z o. o.

DVOUZÁVITOVÝ ŠROUB



- ▶ M10x200 A2 kompletní set dílů
- ▶ M10x250 A2 kompletní set dílů
- ▶ M10x300 A2 kompletní set dílů

W&H Sp. z o. o.

LÍMCOVÁ MATICE



▶ M10

W&H Sp. z o. o.

T-MATICE RHOMBUS



▶ M8

W&H Sp. z o. o.

FARMÁŘSKÝ VRUT



▶ 4,8x55

W&H Sp. z o. o.

ŠROUB DO PLECHU



▶ 5,5x25 EPDM

W&H Sp. z o. o.

MOSAZENÝ ŠROUB



▶ 8x50, 6x60, 6x100

W&H Sp. z o. o.

POSUVNÁ DRÁŽKA S KULIČKOU



► M8

W&H Sp. z o. o.

ZEMNÍČÍ DESKA



► inox

W&H Sp. z o. o.

STŘEDOVÁ SVORKA



► stříbrná/černá

W&H Sp. z o. o.

KONCOVÁ SVORKA

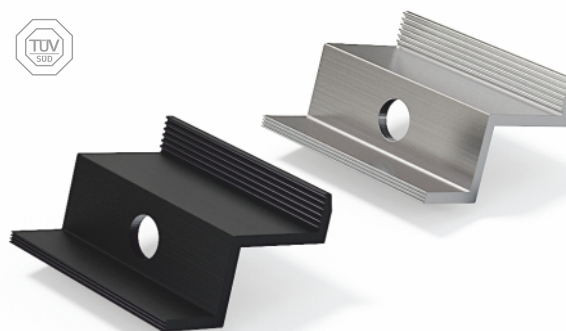

► 30, 32, 35, 40
► stříbrná/černá

W&H Sp. z o. o.

MONTÁŽNÍ ADAPTÉR



► ocelový: 30x5
► hliníkový: 30x5, 40x5

W&H Sp. z o. o.

SPOJKA MONTÁŽNÍCH PROFILŮ



► 40x40, 80x40

W&H Sp. z o. o.

NÁSTAVEC 40X40

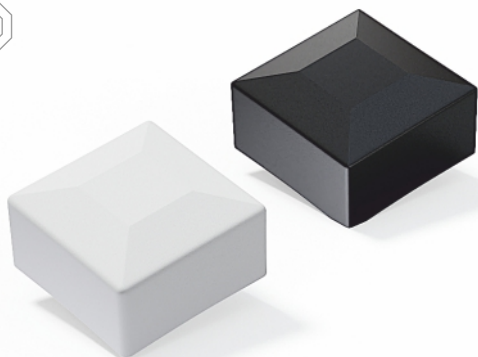

▶ stříbrná/černá

W&H Sp. z o. o.

NÁSTAVEC 80X40



▶ stříbrná/černá

W&H Sp. z o. o.

NÁSTAVEC OD BERANIDLA



▶ černá

W&H Sp. z o. o.

TRAPÉZOVÝ MŮSTEK T40

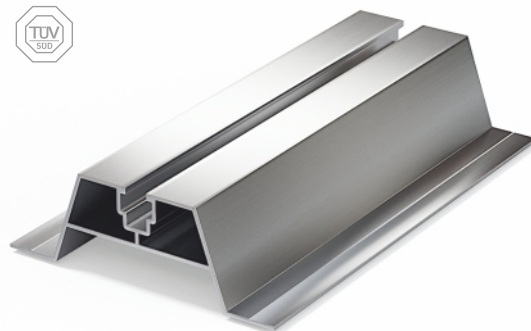

- ▶ T40 330mm s EPDM
- ▶ T40 400mm s EPDM
- ▶ T40 470mm s EPDM

W&H Sp. z o. o.

TRAPÉZOVÝ MŮSTEK T70



- ▶ T70 330mm s EPDM
- ▶ T70 400mm s EPDM
- ▶ T70 470mm s EPDM

W&H Sp. z o. o.

ŠIKMÝ MŮSTEK PRO PLECHOVOU KRYTINU

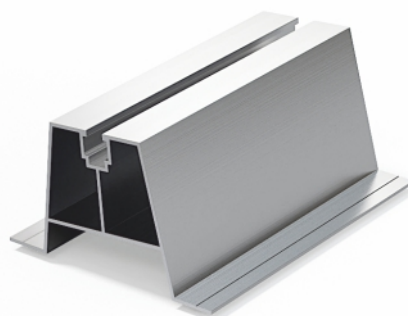

▶ 330mm

W&H Sp. z o. o.

TRAPÉZOVÝ MŮSTEK T40 MAGNELIS



- ▶ T40 330mm s EPDM
- ▶ T40 400mm s EPDM
- ▶ T40 470mm s EPDM

W&H Sp. z o. o.

TRAPÉZOVÝ MŮSTEK T70 MAGNELIS



- ▶ T70 330mm s EPDM
- ▶ T70 400mm s EPDM
- ▶ T70 470mm s EPDM

W&H Sp. z o. o.

JEDNOSTRANNÝ MŮSTEK, KLIK SYSTÉM

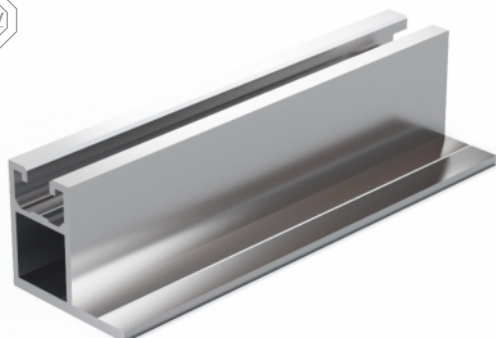

W&H Sp. z o. o.

OBOUSTRANNÝ MŮSTEK, KLIK SYSTÉM

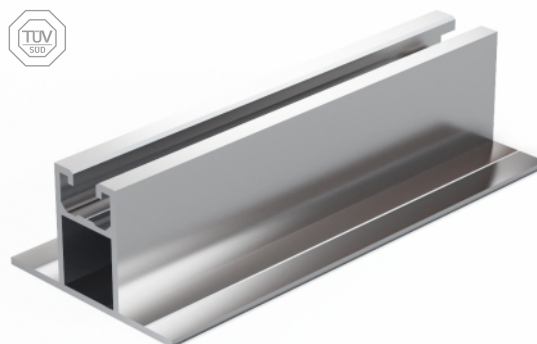

W&H Sp. z o. o.

KONCOVÉ SVORKY PRO KLIK SYSTÉM

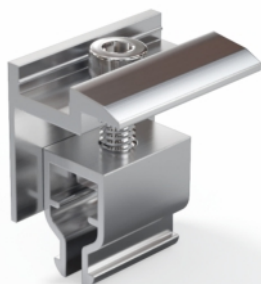

W&H Sp. z o. o.

STŘEDOVÉ SVORKY PRO KLIK SYSTÉM

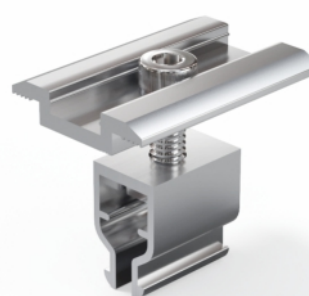

W&H Sp. z o. o.

HLINÍKOVÝ PROFIL PRO ŠROUB S ŠESTIHRANNOU HLAVOU

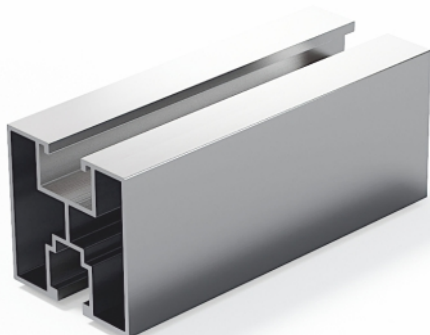

▶ 40X40 Šroub s šestihrannou hlavou

W&H Sp. z o. o.

HLINÍKOVÝ PROFIL PRO ŠROUB S Kladívkovou HLAVOU

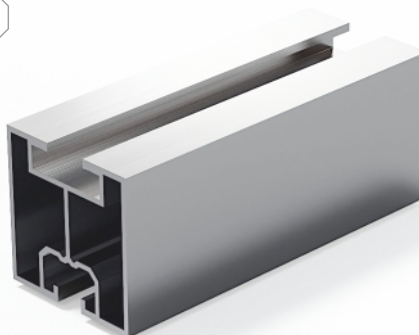

▶ 40X40 Šroub s kladívkovou hlavou

W&H Sp. z o. o.

HLINÍKOVÝ PROFIL „ANGLICKÝ“



▶ 40X40

W&H Sp. z o. o.

DRŽÁK S DRÁŽKOU



▶ UBR

W&H Sp. z o. o.

DISTANČNÍ KUS EPDM



W&H Sp. z o. o.

NASTAVITELNÝ DRŽÁK PRO PLECHOVOU STŘEŠNÍ KRYTINU „JÁNOŠÍK“



W&H Sp. z o. o.

NASTAVITELNÝ DRŽÁK L



▶ ULR175

W&H Sp. z o. o.

DRŽÁK BEZ NASTAVENÍ L



▶ ULN175

W&H Sp. z o. o.

NASTAVITELNÝ DRŽÁK S



▶ USR420, USR450, USR480, USR500
▶ USR520, USR550, USR570, USR600

W&H Sp. z o. o.

DRŽÁK BEZ NASTAVENÍ S



▶ USN460, USN470, USN480, USN500
▶ USN520, USN550, USN560

W&H Sp. z o. o.

NASTAVITELNÝ DRŽÁK T NA PLECHOVOU STŘEŠNÍ KRYTINU



▶ UDB350, UDB400

W&H Sp. z o. o.

NASTAVITELNÝ DRŽÁK T NA PLOCHOU STŘEŠNÍ KRYTINU



▶ UKR305

W&H Sp. z o. o.

**DRŽÁK NA PLOCHOU
STŘEŠNÍ KRYTINU BEZ NASTAVENÍ**



▶ UKN305

W&H Sp. z o. o.

**DRŽÁK NA PLOCHOU
STŘEŠNÍ KRYTINU ŠIROKÝ**



▶ 300mm

W&H Sp. z o. o.

**DRŽÁK NA KROKEV
S DVOJITÝM NASTAVENÍM I**



▶ 140mm Vario I

W&H Sp. z o. o.

**DRŽÁK NA KROKEV
S DVOJITÝM NASTAVENÍM II**



▶ 140mm Vario II

W&H Sp. z o. o.

**DRŽÁK NA KROKEV
S DVOJITÝM NASTAVENÍM III**



▶ 140mm Vario III

W&H Sp. z o. o.

**DRŽÁK NA KROKEV
S „ANGLICKÝM“ PROFILEM**



▶ 140mm Vario IV

W&H Sp. z o. o.

MONTÁŽNÍ TROJHRAN MALÝ



▶ Horizontální orientace modulů 15° 25°

W&H Sp. z o. o.

MONTÁŽNÍ TROJHRAN VELKÝ



▶ Vertikální orientace modulů 15° 25°

W&H Sp. z o. o.

MONTÁŽNÍ TROJHRAN VELKÝ NASTAVITELNÝ



▶ Vertikální orientace modulů

W&H Sp. z o. o.

TROJHRAN MAGNELIS NASTAVITELNÝ, JIH 15/20°



▶ Horizontální orientace modulů 15° 20°

W&H Sp. z o. o.

TROJHRAN MAGNELIS VÝCHOD-ZÁPAD 15°



▶ Horizontální orientace modulů 15°

W&H Sp. z o. o.

TROJHRAN MAGNELIS MODULOVÝ, JIH 15°



▶ Horizontální orientace modulů 15°

W&H Sp. z o. o.

MONTÁŽNÍ DESKA

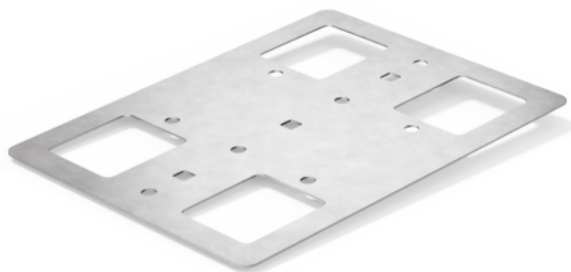

▶ 300x225x1,5mm

W&H Sp. z o. o.

ŠROUB S PŘÍTLAČNOU DESKOU NA PODLOŽCE Z EPDM



▶ fi 80mm

W&H Sp. z o. o.

MONTÁŽNÍ TROJHRAN MAGNELIS ŠÍROKÝ



▶ Horizontální orientace modulů 15° 25°

W&H Sp. z o. o.

STOJAN NA TEPELNÉ ČERPADLO MALÝ



▶ délka: 480, 780 šířka: 430 výška: 430

W&H Sp. z o. o.

STOJAN NA TEPELNÉ ČERPADLO VELKÝ



▶ délka: 735, 1200 šířka: 430 výška: 430

W&H Sp. z o. o.

STOJAN NA STRÍDAČ



▶ šířka: 1485, 2000 výška: 3000



📍 **W&H Sp. z o.o.**

ul. Kościuszki 49,
44-351 Turza Śląska,
Polsko

☎ +48 791 730 721

✉ oferta@hetmaniok.pl

hetmaniok.pl

