



# STRUCTURES POUR LE MONTAGE

DE PANNEAUX PHOTOVOLTAÏQUES

---

CATALOGUE DE PRODUITS

| 2024



ISO 9001  
EN ISO 1090  
EN ISO 3834 2

📍 **W&H Sp. z o.o.**

ul. Kościuszki 49,  
44-351 Turza Śląska,  
Pologne

☎ +48 794 730 721

+48 575 530 721

+48 794 930 721

✉ [biuro@hetmaniok.pl](mailto:biuro@hetmaniok.pl)

🖱 [hetmaniok.pl](http://hetmaniok.pl)

# CATALOGUE DE PRODUITS

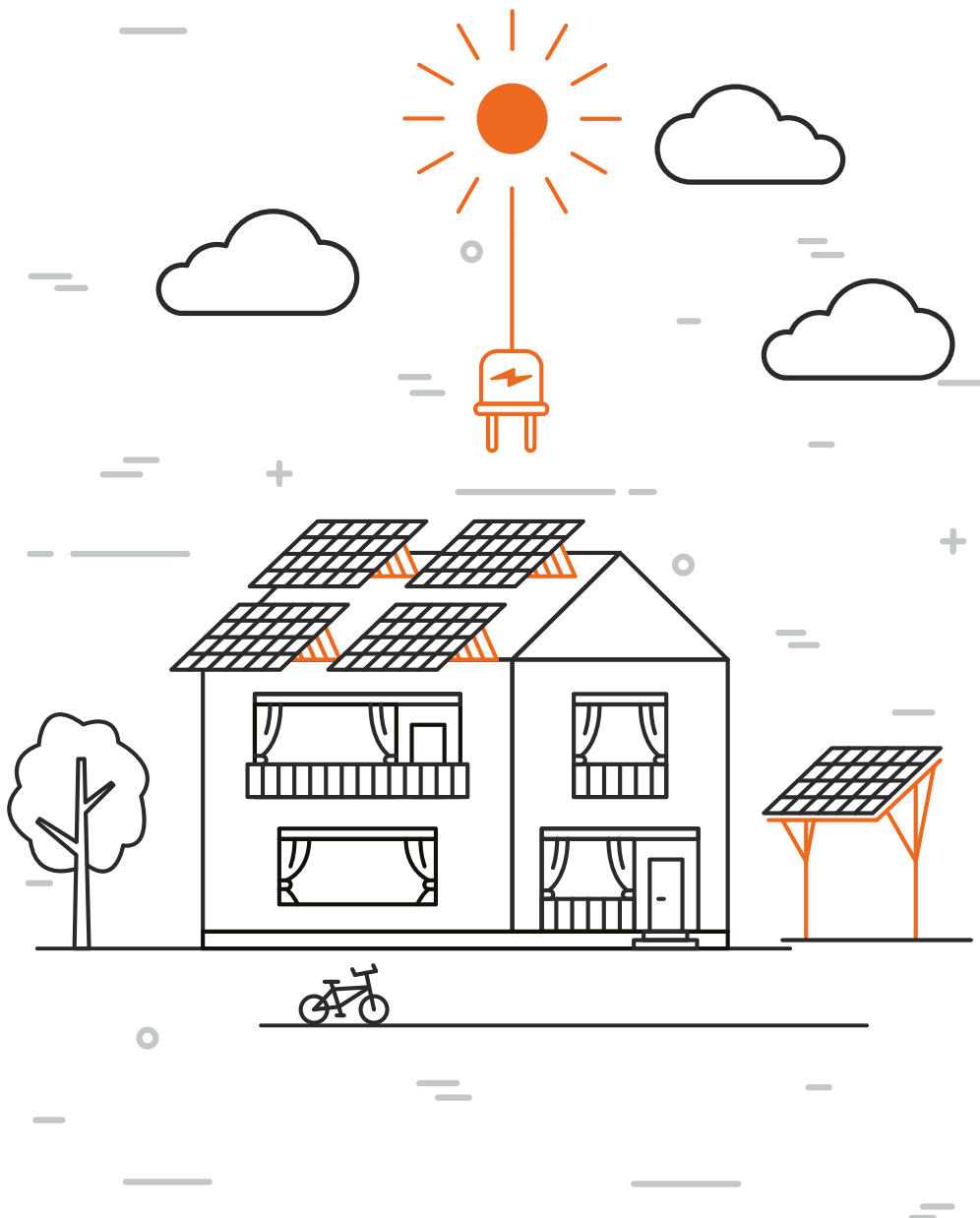

STRUCTURES POUR LE MONTAGE  
DE PANNEAUX PHOTOVOLTAÏQUES

W&H Sp. z o. o.

# STRUCTURES POUR TOITS EN PENTE



- ▶ Nombre de modules : à partir de 2
- ▶ Certification TÜV



**TÔLES À JOINT**



**TÔLES TRAPÉZOÏDALES**



**TÔLE TRAPÉZOÏDALE, SYSTÈME KLIK, HORIZONTAL**

En Pologne, les toitures en pente sont les plus courantes. Les panneaux photovoltaïques peuvent également être installés sur ce type de toiture. Leur installation nécessite une structure adaptée, et en particulier une solution de fixation efficace qui dépend du type de couverture.



**TÔLE TRAPÉZOÏDALE, SYSTÈME KLIK, VERTICAL**

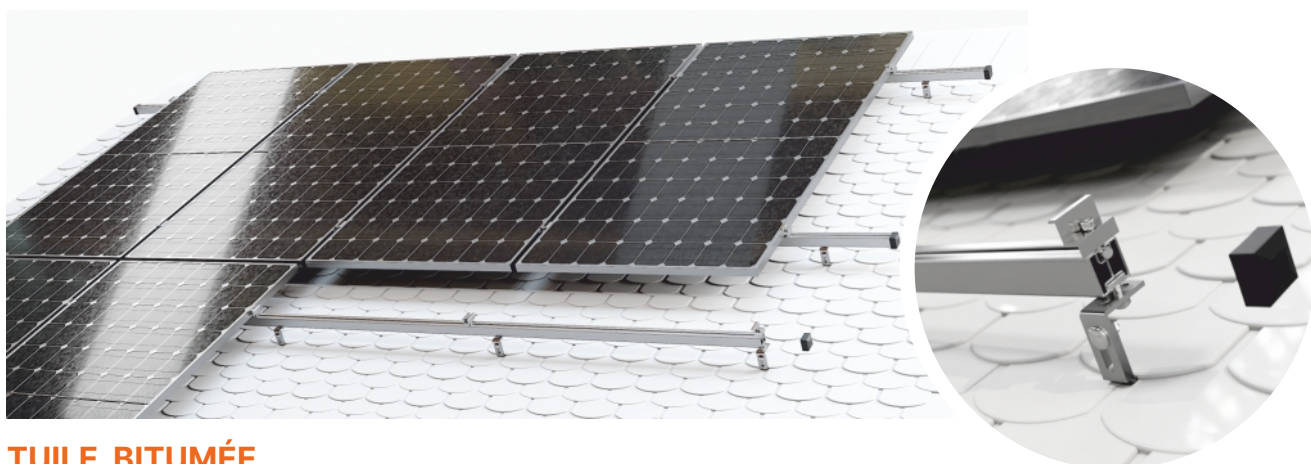

**TUILE BITUMÉE**



**TUILE BITUMÉE, DOUBLE FILETAGE**



**TUILES EN CÉRAMIQUE/BÉTON**

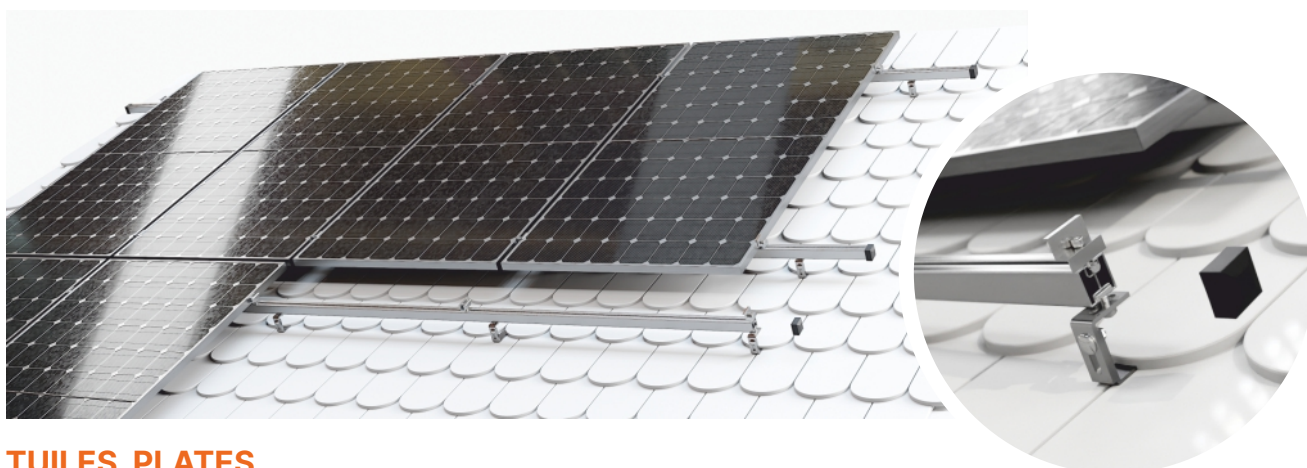

**TUILES PLATES**



**TÔLE IMITATION TUILES, SUPPORT AJUSTABLE**

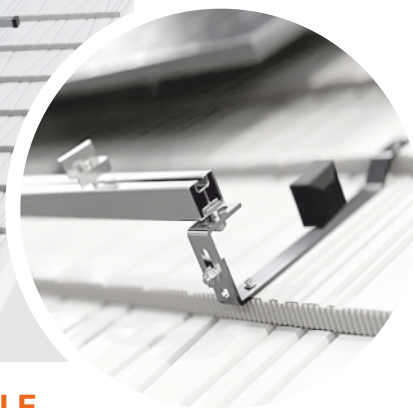

**TÔLE IMITATION TUILES „JANOSIK”, SUPPORT AJUSTABLE**

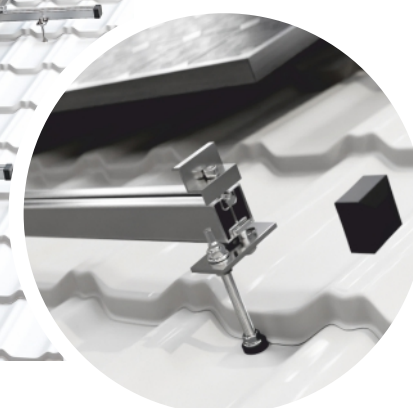

**TÔLE IMITATION TUILES, DOUBLE FILETAGE**

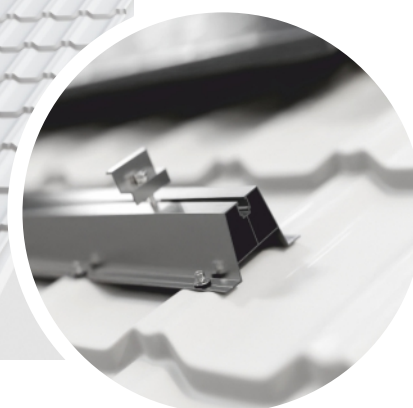
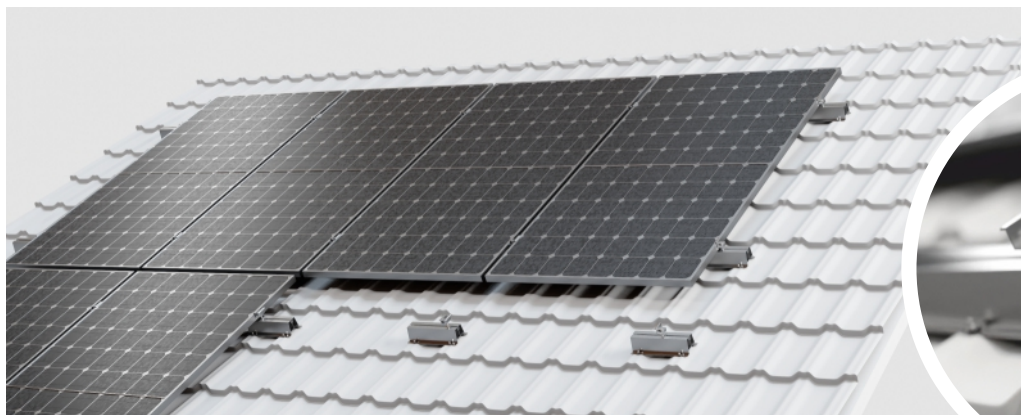

**TÔLE IMITATION TUILES, STRUCTURE EN PONT**

W&H Sp. z o. o.

# STRUCTURES POUR TOITS PLATS



▶ Nombre de modules : à partir de 2  
▶ Certification TÜV

Les systèmes photovoltaïques montés sur un toit plat demandent la mise en place de structures qui permettent aux rayons du soleil de tomber à l'angle optimal sur les cellules photovoltaïques.

Nous avons élaboré des systèmes basés sur :

- des supports hauts et bas,
- des triangles en aluminium permettant un montage tant invasif que non invasif.



**STRUCTURE À BALLAST AERO  
SUD**

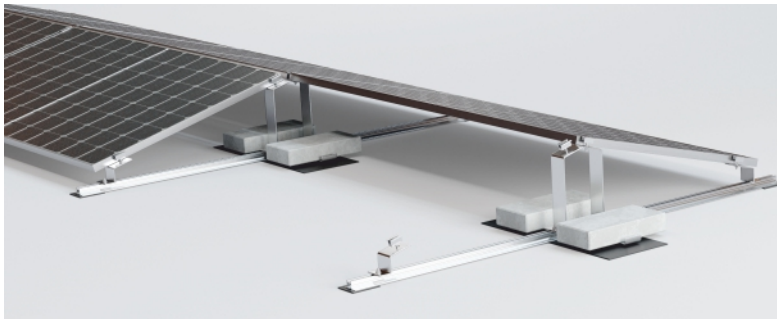

**STRUCTURE À BALLAST AERO  
EST-OUEST**



**STRUCTURE LESTÉE AERO  
SUD**







**STRUCTURE LESTÉE  
À BALLAST EST-OUEST**



**STRUCTURE  
À CONSOLES**



**STRUCTURE PORTANTE  
SUR RAILS AERO**

STRUCTURES POUR TOITS PLATS

# MAGNELIS TRIANGLE

- ▶ Nombre de modules : à partir de 1
- ▶ Certification TÜV



**SUD 15/20° DEGRÉS CONSOLES  
SUR TOITURE FEUTRE/MEMBRANE**



**SUD 15/20°  
DEGRÉS VIS À DOUBLE FILETAGE**

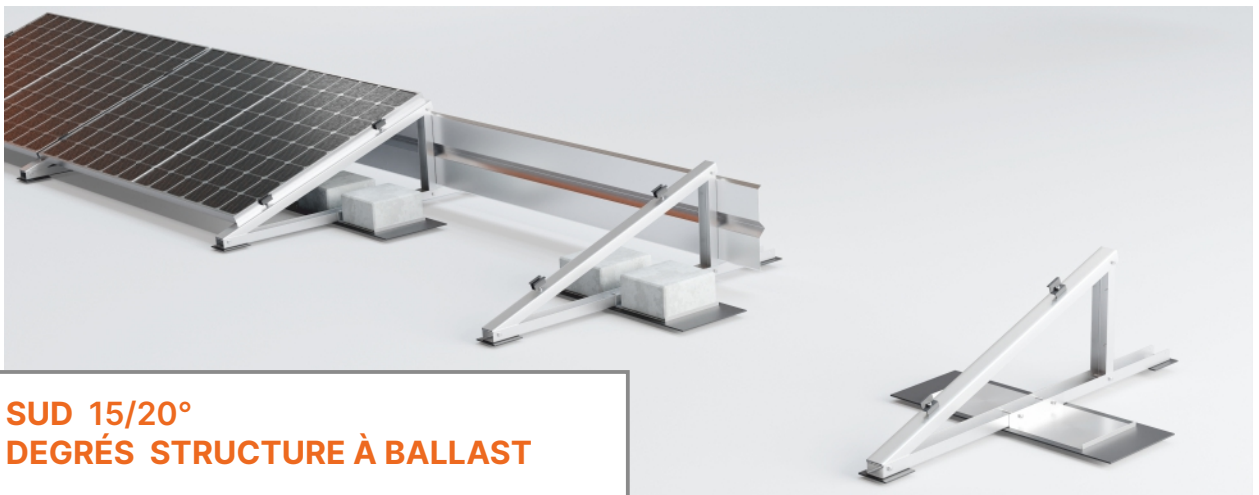

**SUD 15/20°  
DEGRÉS STRUCTURE À BALLAST**

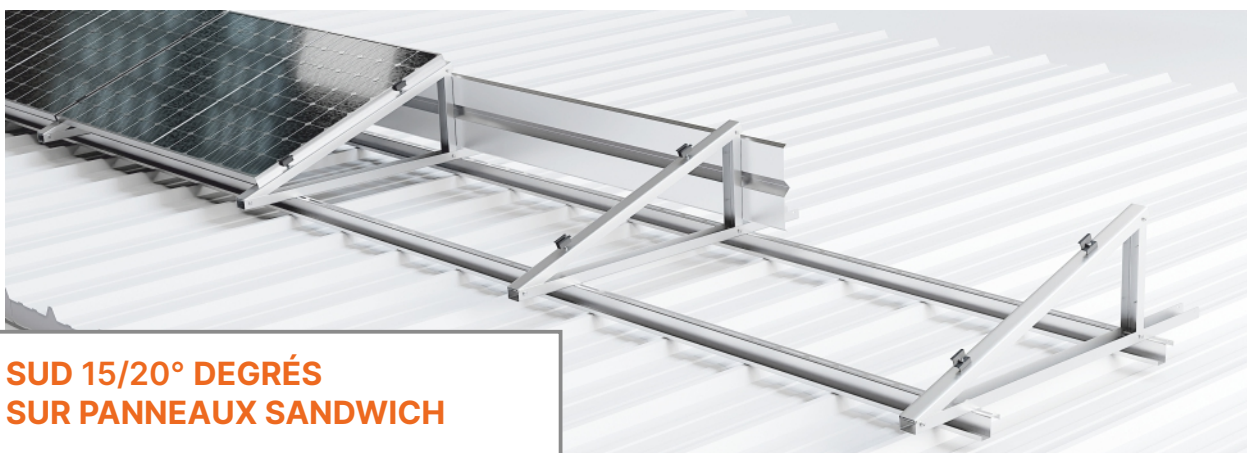

**SUD 15/20° DEGRÉS  
SUR PANNEAUX SANDWICH**



**SUD 15/20° DEGRÉS BIFACIAL  
SUR PANNEAUX SANDWICH**

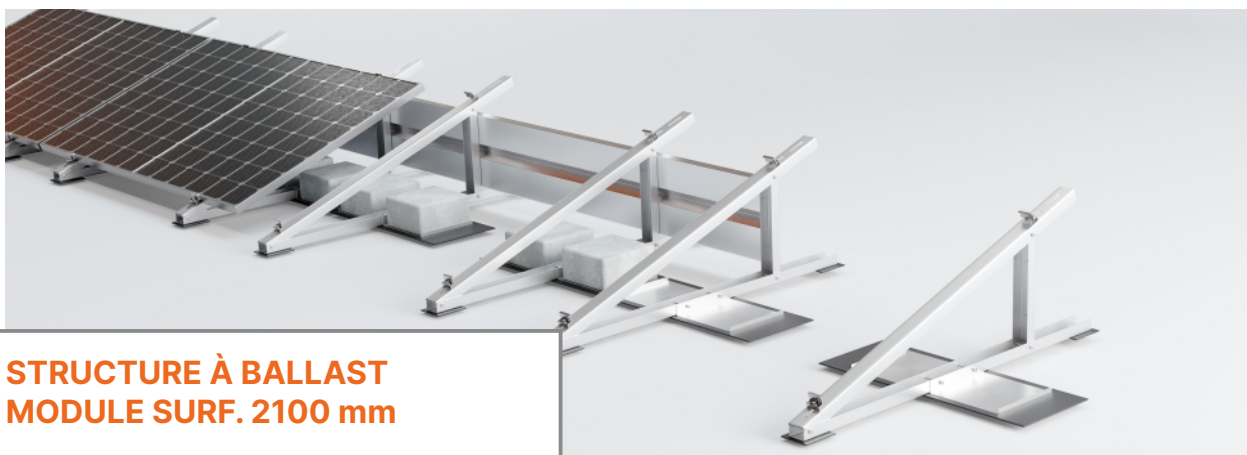

**STRUCTURE À BALLAST  
MODULE SURF. 2100 mm**



**STRUCTURE À CONSOLES  
MODULE SURF. 2100 mm**



**STRUCTURE À CONSOLES  
TRIANGLE MAGNELIS LARGE**



**STRUCTURE À BALLAST  
TRIANGLE MAGNELIS LARGE**



**STRUCTURE SUR RAILS AERO  
TRIANGLE MAGNELIS LARGE**



**STRUCTURE SUR RAILS AERO  
MODULE SURF. 2100 mm**

STRUCTURES POUR TOITS PLATS

# MAGNELIS TRIANGLE

- ▶ Nombre de modules : à partir de 2
- ▶ Certification TÜV



**2 RANGÉES SUD 15/20° DEGRÉS CONSOLES  
SUR TOITURE FEUTRE/MEMBRANE**



**2 RANGÉES SUD 15/20°  
DEGRÉS VIS À DOUBLE FILETAGE**

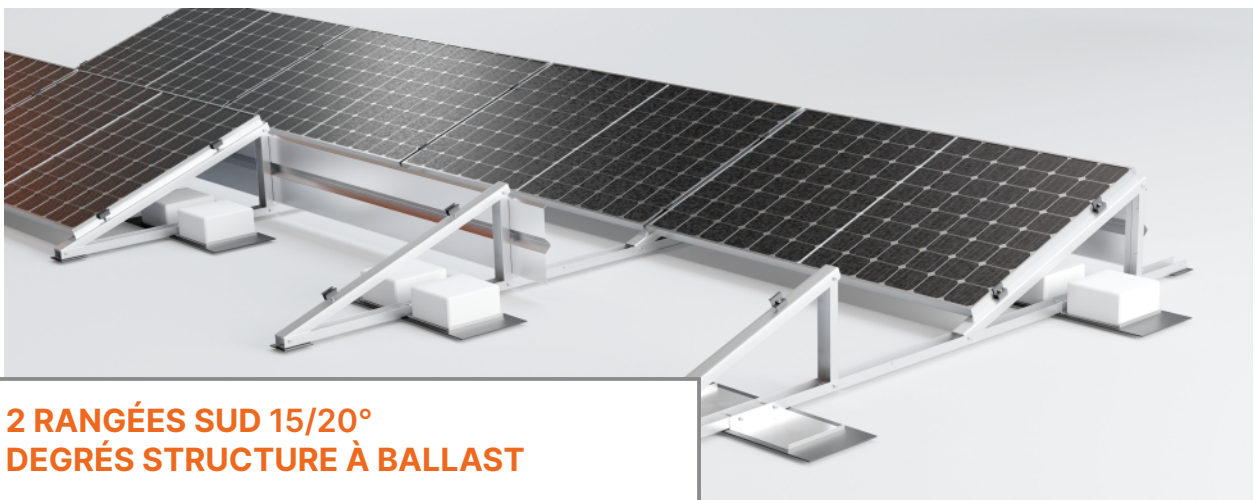

**2 RANGÉES SUD 15/20°  
DEGRÉS STRUCTURE À BALLAST**

STRUCTURES POUR TOITS PLATS

# MAGNELIS TRIANGLE

- ▶ Nombre de modules : à partir de 2
- ▶ Certification TÜV



**EST-OUEST  
SUR TOITURE FEUTRE/MEMBRANE**



**EST-OUEST  
DEGRÉS VIS À DOUBLE FILETAGE**

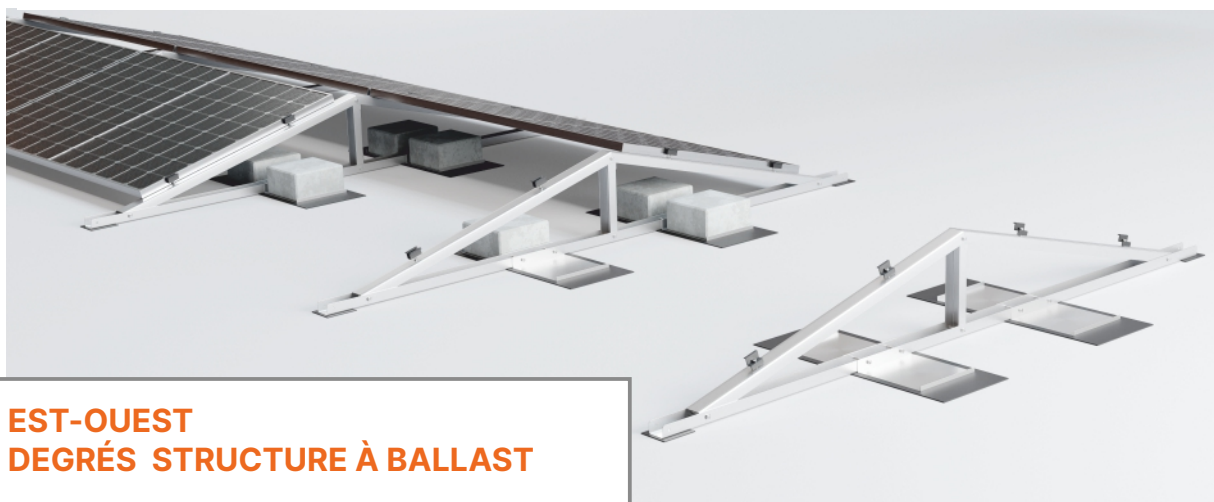

**EST-OUEST  
DEGRÉS STRUCTURE À BALLAST**



**STRUCTURE PARALLÈLE AU TOIT,  
VIS À PRESSION**



**STRUCTURE POUR BALCON,  
TRIANGLE MAGNELIS 15°**



**CLÔTURE PHOTOVOLTAÏQUE  
1 PANNEAU VERTICAL BIFACIAL**

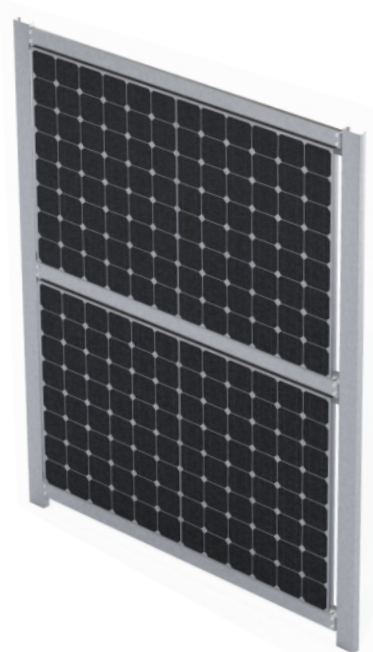

**CLÔTURE PHOTOVOLTAÏQUE  
2 PANNEAUX HORIZONTAUX BIFACIAUX**

STRUCTURES  
AUTOPORTANTES

# SUPPORT DOUBLE



STRUCTURE  
ACIER/MAGNELIS



**2 PANNEAUX  
VERTICAUX**

- ▶ Nombre de modules : à partir de 2
- ▶ Certification TÜV



**4 PANNEAUX  
HORIZONTALAUX**

- ▶ Nombre de modules : à partir de 4
- ▶ Certification TÜV



Du fait de leur ancrage dans le sol, les structures autoportantes requièrent une mise au point particulièrement soignée de tous leurs composants. En fonction de vos besoins, des structures à simple ou double support sont disponibles.



**STRUCTURE  
ACIER/ALUMINIUM**



**2 PANNEAUX  
VERTICAUX**

- ▶ Nombre de modules : à partir de 2
- ▶ Certification TÜV



**3 PANNEAUX  
HORIZONTALAUX**

- ▶ Nombre de modules : à partir de 3
- ▶ Certification TÜV



**4 PANNEAUX  
HORIZONTALAUX**

- ▶ Nombre de modules : à partir de 4
- ▶ Certification TÜV



**5 PANNEAUX  
HORIZONTALAUX**

- ▶ Nombre de modules : à partir de 5
- ▶ Certification TÜV

Du fait de leur ancrage dans le sol, les structures autoportantes requièrent une mise au point particulièrement soignée de tous leurs composants. En fonction de vos besoins, des structures à simple ou double support sont disponibles.



**STRUCTURE  
ACIER/MAGNELIS**



**2 PANNEAUX  
VERTICAUX  
BIFACIAL**

- ▶ Nombre de modules : à partir de 2
- ▶ Certification TÜV



**3 PANNEAUX  
HORIZONTALAUX**

- ▶ Nombre de modules : à partir de 3
- ▶ Certification TÜV



**3 PANNEAUX  
HORIZONTALAUX  
BIFACIAL**

- ▶ Nombre de modules : à partir de 3
- ▶ Certification TÜV



**4 PANNEAUX  
HORIZONTALAUX  
BIFACIAL**

- ▶ Nombre de modules : à partir de 4
- ▶ Certification TÜV

STRUCTURES  
AUTOPORTANTES

# SUPPORT SIMPLE



STRUCTURE  
ACIER/ALUMINIUM



## 2 PANNEAUX VERTICAUX

- ▶ Nombre de modules :  
à partir de 2
- ▶ Certification TÜV



## 3 PANNEAUX HORIZONTAUX

- ▶ Nombre de modules :  
à partir de 3
- ▶ Certification TÜV

STRUCTURES  
AUTOPORTANTES

# CARPORT



STRUCTURE  
ALUMINIUM

pour les modules > 25 kg

STRUCTURE  
ACIER



STRUCTURE  
ALUMINIUM  
OU ACIER



SYSTÈME  
D'ASSEMBLAGE  
MODULAIRE



TOUTES  
LES COULEURS  
RAL AU CHOIX

Notre gamme de produits comprend des carports simples et doubles en aluminium et en acier, avec possibilité d'assemblage modulaire. Un carport simple a une largeur de 2,5 mètres (selon les exigences actuelles).

Les carports peuvent être réalisés selon les besoins personnels du client. Ils peuvent être peints dans n'importe quelle couleur de la palette RAL.

# ÉLÉMENTS POUR STRUCTURES DE MONTAGE

En tant que fabricant de structures de montage, nous disposons de solutions éprouvées pour tout type de toit avec tout type de couverture. Nous mettons l'accent sur la qualité et la durabilité de tous nos composants.

W&H Sp. z o. o.

## VIS À TÊTE CYLINDRIQUE



- ▶ M8x20
- ▶ M8x25
- ▶ M8x30
- ▶ M8x35

W&H Sp. z o. o.

## VIS À TÊTE HEXAGONALE



- ▶ M10x25

W&H Sp. z o. o.

## VIS À TÊTE MARTEAU



- ▶ M10x25
- ▶ M10x30

W&H Sp. z o. o.

## VIS DE BLOCAGE



- ▶ M10x25

W&H Sp. z o. o.

### VIS À DOUBLE FILETAGE



- ▶ M10x200 A2 complet
- ▶ M10x250 A2 complet
- ▶ M10x300 A2 complet

W&H Sp. z o. o.

### ÉCROU À COLLERETTE



- ▶ M10

W&H Sp. z o. o.

### ÉCROU EN LOSANGE



- ▶ M8

W&H Sp. z o. o.

### VIS DE TOITURE



- ▶ 4,8x55

W&H Sp. z o. o.

### VIS À TÔLE



- ▶ 5,5x25 EPDM

W&H Sp. z o. o.

### VIS JAUNE



- ▶ 8x50, 6x60, 6x100

W&H Sp. z o. o.

**RAINURE DE GLISSEMENT  
À BILLE**



▶ M8

W&H Sp. z o. o.

**PLAQUE DE MISE  
À LA TERRE**



▶ inox

W&H Sp. z o. o.

**PIÈCE ADHÉSIVE CENTRALE**

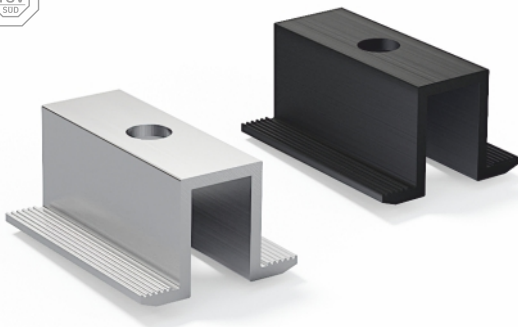

▶ argent / noir

W&H Sp. z o. o.

**PIÈCE ADHÉSIVE D'EXTRÉMITÉ**

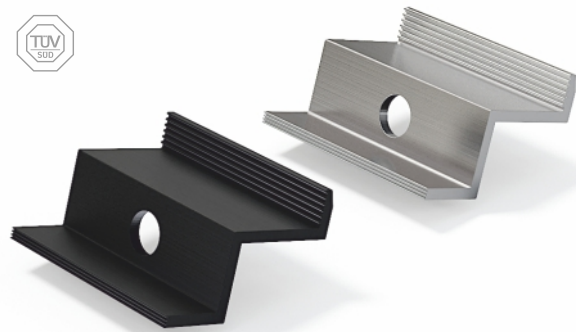

▶ 30, 32, 35, 40  
▶ argent / noir

W&H Sp. z o. o.

**ADAPTATEUR DE MONTAGE**



▶ acier: 30x5  
▶ aluminium: 30x5, 40x5

W&H Sp. z o. o.

**CONNECTEUR DE PROFILÉ  
DE MONTAGE**



▶ 40x40, 80x40

W&H Sp. z o. o.

**MANCHON DE FIXATION 40X40**

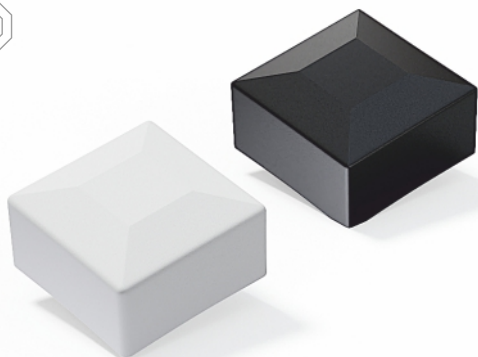

▶ argent / noir

W&H Sp. z o. o.

**MANCHON DE FIXATION 80X40**



▶ argent / noir

W&H Sp. z o. o.

**MANCHON DE PILIER**



▶ noir

W&H Sp. z o. o.

**PONT TRAPÉZOÏDAL T40**

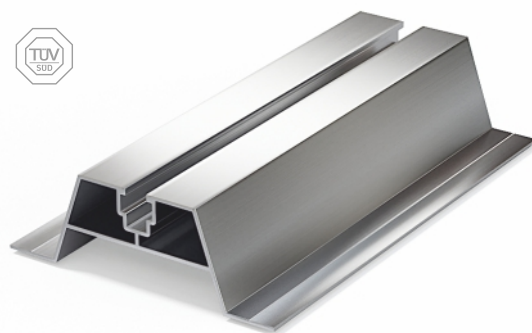

- ▶ T40 330mm avec EPDM
- ▶ T40 400mm avec EPDM
- ▶ T40 470mm avec EPDM

W&H Sp. z o. o.

**PONT TRAPÉZOÏDAL T70**



- ▶ T70 330mm avec EPDM
- ▶ T70 400mm avec EPDM
- ▶ T70 470mm avec EPDM

W&H Sp. z o. o.

**PONT DIAGONAL T70  
POUR TÔLE IMITATION TUILES**



▶ 330mm



W&H Sp. z o. o.

**PONT TRAPÉZOÏDAL  
T40 MAGNELIS**



- ▶ T40 330mm avec EPDM
- ▶ T40 400mm avec EPDM
- ▶ T40 470mm avec EPDM

W&H Sp. z o. o.

**PONT TRAPÉZOÏDAL  
T70 MAGNELIS**



- ▶ T70 330mm avec EPDM
- ▶ T70 400mm avec EPDM
- ▶ T70 470mm avec EPDM

W&H Sp. z o. o.

**PONT UNILATÉRAL  
SYSTÈME KLIK**

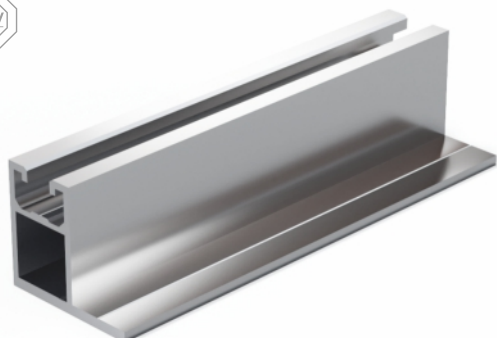

W&H Sp. z o. o.

**PONT BILATÉRAL,  
SYSTÈME KLIK**

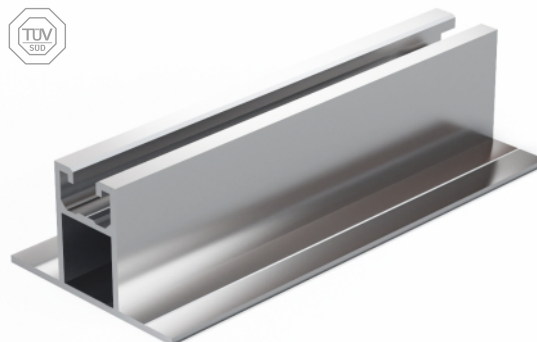

W&H Sp. z o. o.

**PIÈCES ADHÉSIVES D'EXTRÉMITÉ  
POUR SYSTÈME KLIK**

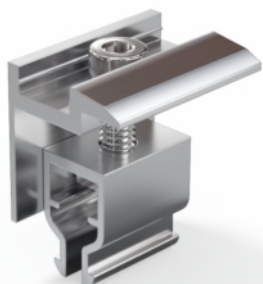

W&H Sp. z o. o.

**PIÈCES ADHÉSIVES CENTRALES  
POUR SYSTÈME KLIK**

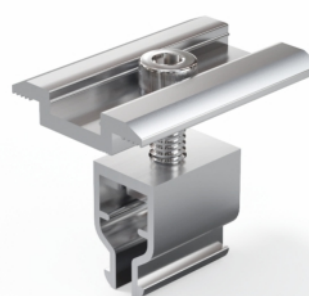

W&H Sp. z o. o.

### PROFILÉ ALU POUR VIS À TÊTE HEXAGONALE

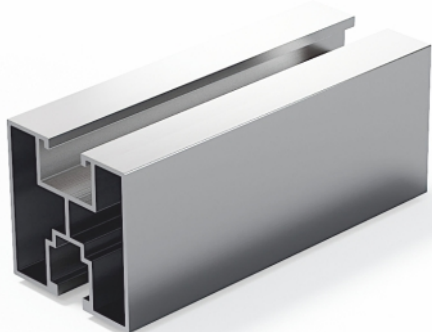

▶ 40X40 Vis à tête hexagonale

W&H Sp. z o. o.

### PROFILÉ ALU POUR VIS À TÊTE EN MARTEAU

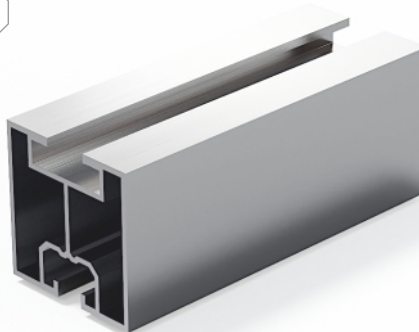

▶ 40X40 Vis à tête marteau

W&H Sp. z o. o.

### PROFILÉ ALU "ANGLAIS „

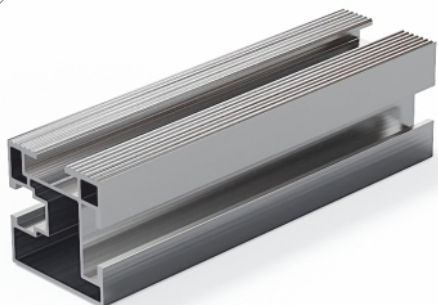

▶ 40X40

W&H Sp. z o. o.

### SUPPORT DE JOINT



▶ UBR

W&H Sp. z o. o.

### ENTRETOISE EPDM



W&H Sp. z o. o.

### SUPPORT RÉGLABLE POUR TÔLES IMITATION TUILES „JANOSIK”



W&H Sp. z o. o.

**SUPPORT RÉGLABLE L**



▶ ULR175

W&H Sp. z o. o.

**SUPPORT NON RÉGLABLE L**



▶ ULN175

W&H Sp. z o. o.

**SUPPORT RÉGLABLE S**



▶ USR420, USR450, USR480, USR500  
▶ USR520, USR550, USR570, USR600

W&H Sp. z o. o.

**SUPPORT NON RÉGLABLE S**



▶ USN460, USN470, USN480, USN500  
▶ USN520, USN550, USN560

W&H Sp. z o. o.

**SUPPORT RÉGLABLE T  
POUR TÔLES IMITATION  
TUILES „JANOSIK”**



▶ UDB350, UDB400

W&H Sp. z o. o.

**SUPPORT RÉGLABLE T  
POUR TÔLES PLATES**



▶ UKR305

W&H Sp. z o. o.

**SUPPORT NON RÉGLABLE  
POUR TÔLES PLATES**



▶ UKN305

W&H Sp. z o. o.

**SUPPORT LARGE  
POUR TÔLES PLATES**



▶ 300mm

W&H Sp. z o. o.

**SUPPORT DE CHEVRON  
DOUBLE RÉGLAGE I**



▶ 140mm Vario I

W&H Sp. z o. o.

**SUPPORT DE CHEVRON  
DOUBLE RÉGLAGE II**



▶ 140mm Vario II

W&H Sp. z o. o.

**SUPPORT DE CHEVRON  
DOUBLE RÉGLAGE III**



▶ 140mm Vario III

W&H Sp. z o. o.

**SUPPORT DE CHEVRON  
AVEC PROFILÉ „ANGLAIS”**



▶ 140mm Vario IV

W&H Sp. z o. o.

### TRIANGLE DE MONTAGE PETIT



► Orientation horizontale des modules 15° 25°

W&H Sp. z o. o.

### TRIANGLE DE MONTAGE GRAND



► Orientation verticale des modules 15° 25°

W&H Sp. z o. o.

### TRIANGLE DE MONTAGE GRAND RÉGLABLE



► Orientation verticale des modules

W&H Sp. z o. o.

### TRIANGLE MAGNELIS RÉGLABLE, SUD 15° 20°



► Orientation horizontale des modules 15° 20°

W&H Sp. z o. o.

### TRIANGLE MAGNELIS EST-OUEST 15°



► Orientation horizontale des modules 15°

W&H Sp. z o. o.

### TRIANGLE MAGNELIS MODULAIRE, SUD 15°



► Orientation horizontale des modules 15°

W&H Sp. z o. o.

**PLAQUE DE MONTAGE**

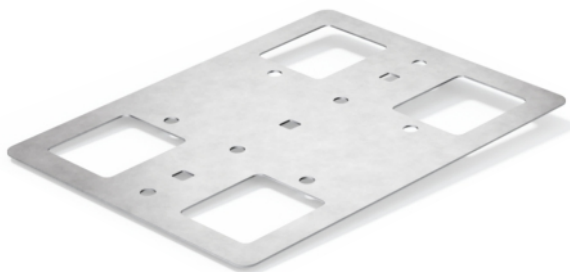

▶ 300x225x1,5mm

W&H Sp. z o. o.

**VIS AVEC PLAQUE DE PRESSION SUR RONDELLE EPDM**



▶ fi 80mm

W&H Sp. z o. o.

**TRIANGLE DE MONTAGE MAGNELIS LARGE**



▶ Orientation horizontale des modules 15° 25°

W&H Sp. z o. o.

**SUPPORT POUR POMPE À CHALEUR PETIT**



▶ longueur: 480, 780    largeur: 430    hauteur: 430

W&H Sp. z o. o.

**SUPPORT POUR POMPE À CHALEUR GRAND**



▶ longueur: 735, 1200    largeur: 430    hauteur: 430

W&H Sp. z o. o.

**SUPPORT POUR ONDULEUR**



▶ largeur: 1485, 2000    hauteur: 3000





📍 **W&H Sp. z o.o.**

ul. Kościuszki 49,  
44-351 Turza Śląska,  
Pologne

☎ +48 730 92 92 92

✉ oferta@hetmaniok.pl

**hetmaniok.pl**

