



MONTAGE
KONSTRUKTIONEN

FÜR PHOTOVOLTAIK

PRODUKTKATALOG

2024



📍 **W&H Sp. z o.o.**

ul. Kościuszki 49,
44 351 Turza Śląska,
Polen

☎ +48 794 730 721
+48 575 530 721
+48 794 930 721

✉ biuro@hetmaniok.pl

🖱 hetmaniok.pl

PRODUKTKATALOG 2024

PHOTOVOLTAIK UNTERKONSTRUKTIONEN
UND BEFESTIGUNGEN

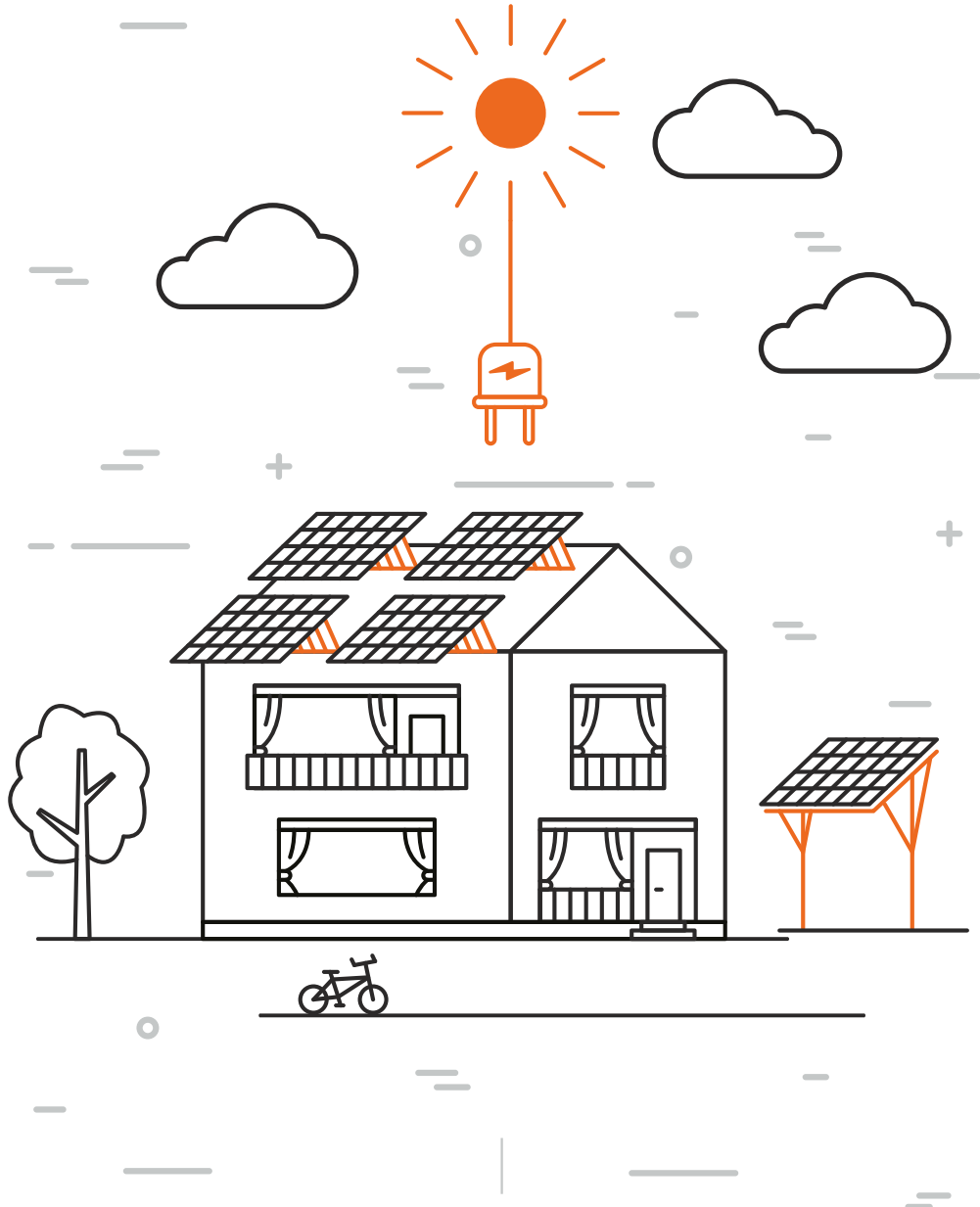

ISO 9001
EN ISO 1090
EN ISO 3834 2

W&H Sp. z o. o.

KONSTRUKTIONEN FÜR SCHRÄGDACH

▶ Anzahl der Module: ab 2
▶ TÜV zertifiziert



FALZBLECH

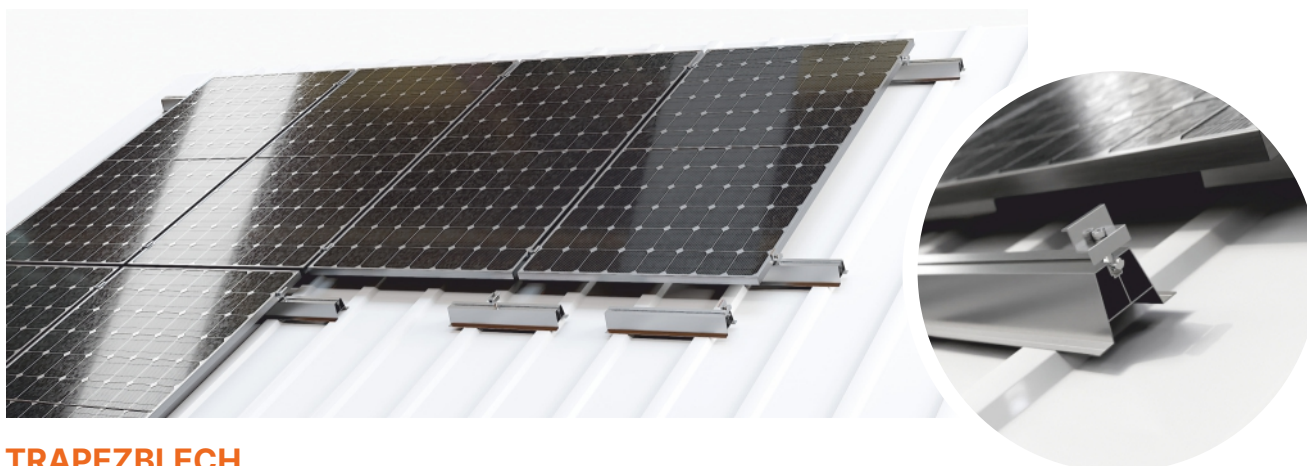

TRAPEZBLECH



TRAPEZBLECH, KLICKSYSTEM, EBENE

Ihr Spezialist für PV-Unterkonstruktionen und PV-Carports in modularer Bauweise.



TRAPEZBLECH, KLICKSYSTEM, VERTIKAL



BITUMEN-DACHZIEGEL



BITUMEN-DACHZIEGEL, DOPPELGEWINDESCHRAUBE



KERAMIK / BETONDACHZIEGEL



BIBERSCHWANZ DACHZIEGEL



BLECHDACH, HALTER EINSTELLBAR

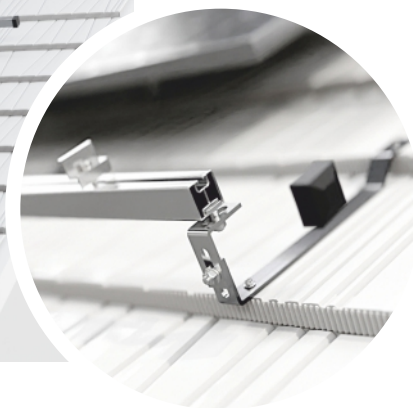

BLECHDACH "JANOSIK", HALTER EINSTELLBAR

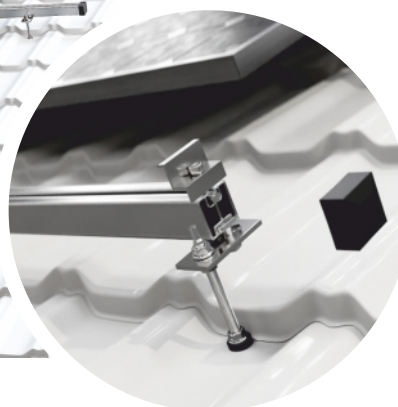

BLECHDACH, DOPPELGEWINDESCHRAUBE

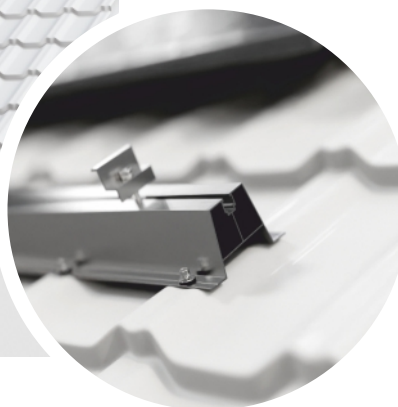

BLECHDACH, KONSTRUKTION AN TRAPEZBRÜCKE

W&H Sp. z o. o.

KONSTRUKTIONEN FÜR FLACHDACH

- ▶ Anzahl der Module: ab 1
- ▶ TÜV zertifiziert



In unserem Angebot haben wir Systeme vorbereitet, die folgende Elemente nutzen:

- ▶ niedriges und hohes Stützelement,
- ▶ Dreiecke aus Aluminium, die sowohl eine invasive als auch eine nicht-invasive Befestigung ermöglichen.



**BALLASTKONSTRUKTION
AERO SÜD**

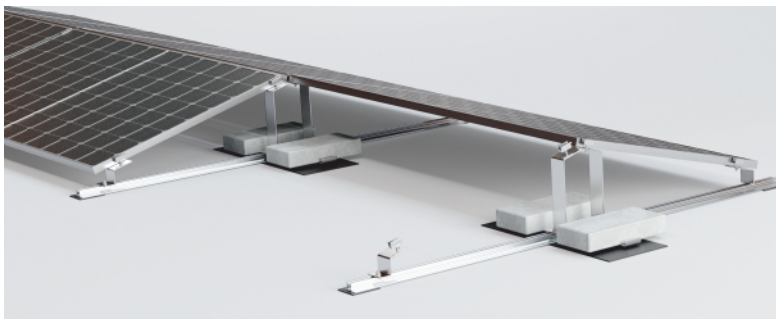
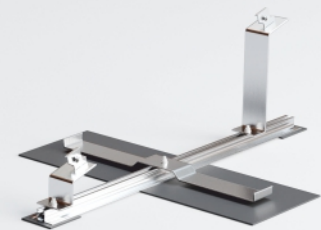

**BALLASTKONSTRUKTION
AERO OST WEST**



**BALLASTKONSTRUKTION
FÜR BELASTUNG, SÜD**





**BALLASTKONSTRUKTION
FÜR BELASTUNG OST WEST**



**GEKLEBTE KONSTRUKTION
STÜTZEN**



**UNTERSTÜTZTE KONSTRUKTION
AUF AERO-SCHIENEN**

UNTERKONSTRUKTIONEN FÜR FLACHDACH

MAGNELIS DREIECK

- ▶ Anzahl der Module: ab 2
- ▶ TÜV zertifiziert



**BITUMENBAHN / MEMBRANE
SÜDEN 15/20°**



**DOPPELGEWINDESCHRAUBE
SÜDEN 15/20°**



**BALLASTKONSTRUKTION
SÜDEN 15/20°**



**SÜDEN 15/20°
FÜR DIE SANDWICHPLATTE**



**SÜDEN 15/20° BIFACIAL
FÜR DIE SANDWICHPLATTE**

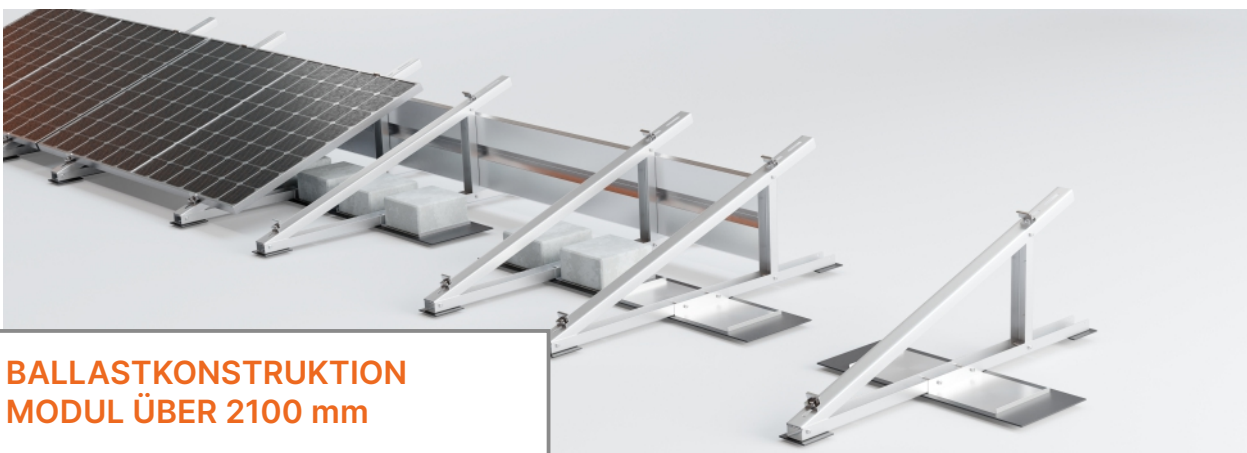

**BALLASTKONSTRUKTION
MODUL ÜBER 2100 mm**



**GEKLEBTE KONSTRUKTION
MODUL ÜBER 2100 mm**



**GEKLEBTE KONSTRUKTION
MAGNELIS DREIECK**



**BALLASTKONSTRUKTION
MAGNELIS DREIECK**



**KONSTRUKTION AUF AERO-SCHIENEN
MAGNELIS DREIECK**



**KONSTRUKTION AUF AERO-SCHIENEN
MODUL ÜBER 2100 mm**



UNTERKONSTRUKTIONEN FÜR FLACHDACH

MAGNELIS DREIECK

- ▶ Anzahl der Module: ab 2
- ▶ TÜV zertifiziert



**2 REIHEN SÜDEN 15/20°
FÜR BITUMENBAHN / MEMBRANE**



**2 REIHEN SÜDEN 15/20°
DOPPELGEWINDESCHRAUBE**



**2 REIHEN SÜDEN 15/20°
BALLASTKONSTRUKTION**

UNTERKONSTRUKTIONEN FÜR FLACHDACH

MAGNELIS DREIECK

- ▶ Anzahl der Module: ab 2
- ▶ TÜV zertifiziert



**OST WEST
FÜR BITUMENBAHN / MEMBRANE**



**OST WEST
DOPPELGEWINDESCHRAUBE**



**OST WEST
BALLASTKONSTRUKTION**



**AUFBAU PARALLEL ZUM DACH
MIT DRUCK SCHRAUBEN**



**BALKONAUFBAU
MAGNELIS DREIECK 15°**



**PHOTOVOLTAIK-ZAUN
1 PANEL VERTIKAL BIFACIAL**

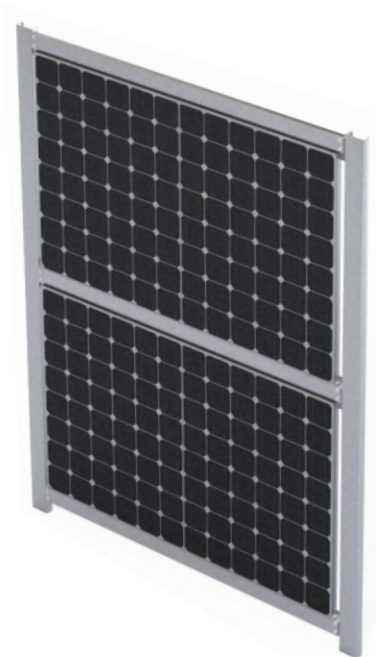

**PHOTOVOLTAIK-ZAUN
2 HORIZONTALE PANEELE BIFACIAL**

FREISTEHENDE
KONSTRUKTIONEN

DOPPELSTÜTZE



STAHL/MAGNELIS
KONSTRUKTIONEN



**2 PANEELE
VERTIKAL**

- ▶ Anzahl der Module: ab 2
- ▶ TÜV zertifiziert



**4 PANEELE
HORIZONTAL**

- ▶ Anzahl der Module: ab 3
- ▶ TÜV zertifiziert

Freistehende Konstruktionen bedürfen aufgrund der Bodenbeschaffenheit eine außergewöhnliche Bearbeitung aller Bauteile. Je nach Bedarf sind Einzel- und Doppelstützkonstruktionen erhältlich.



**STAHL/ALUMINIUM
KONSTRUKTIONEN**



**2 PANELEE
VERTIKAL**

- ▶ Anzahl der Module: ab 2
- ▶ TÜV zertifiziert



**3 PANELEE
HORIZONTAL**

- ▶ Anzahl der Module: ab 3
- ▶ TÜV zertifiziert



**4 PANELEE
HORIZONTAL**

- ▶ Anzahl der Module: ab 4
- ▶ TÜV zertifiziert



**5 PANELEE
HORIZONTAL**

- ▶ Anzahl der Module: ab 5
- ▶ TÜV zertifiziert

Freistehende Konstruktionen bedürfen aufgrund der Bodenbeschaffenheit eine außergewöhnliche Bearbeitung aller Bauteile. Je nach Bedarf sind Einzel- und Doppelstützkonstruktionen erhältlich.



**STAHL/MAGNELIS
KONSTRUKTIONEN**



**2 PANEELE
VERTIKAL
BIFACIAL**

- ▶ Anzahl der Module: ab 2
- ▶ TÜV zertifiziert



**3 PANEELE
HORIZONTAL**

- ▶ Anzahl der Module: ab 3
- ▶ TÜV zertifiziert



**3 PANEELE
HORIZONTAL
BIFACIAL**

- ▶ Anzahl der Module: ab 3
- ▶ TÜV zertifiziert



**4 PANEELE
HORIZONTAL
BIFACIAL**

- ▶ Anzahl der Module: ab 4
- ▶ TÜV zertifiziert

FREISTEHENDE
KONSTRUKTIONEN

EINZELSTÜTZE



2 PANEELE VERTIKAL

- ▶ Anzahl der Module: ab 2
- ▶ TÜV zertifiziert



3 PANEELE HORIZONTAL

- ▶ Anzahl der Module: ab 3
- ▶ TÜV zertifiziert

FREISTEHENDE
KONSTRUKTIONEN

CARPORT



ALUMINIUMKONSTRUKTION

MODUL SCHWERER > 25 kg

STAHLKONSTRUKTION



ALUMINIUM ODER
STAHLKONSTRUKTION



MODULARES
VERBINDUNGSSYSTEM



BELIEBIGE FARBE
AUS DER
RAL PALETTE

Unser Angebot besteht aus Aluminium
sowie Stahl-Carports.
Durch unsere modulare Bauweise.
Können Wir individuelle Stellplätze anbieten

Verfügbar in allen RAL Farben

ELEMENT MONTAGEKONSTRUKTIONEN

Als Hersteller von Montagekonstruktionen verfügen wir über diverse Montagemöglichkeiten für jede Art von Dach. Wir setzen auf Qualität und Langlebigkeit aller Konstruktionselemente.

W&H Sp. z o. o.

INBUSSCHRAUBE



- ▶ M8x20
- ▶ M8x25
- ▶ M8x30
- ▶ M8x35

W&H Sp. z o. o.

SECHSKANSCHRAUBE



- ▶ M10x25

W&H Sp. z o. o.

HAMMERSCHRAUBE



- ▶ M10x25
- ▶ M10x30

W&H Sp. z o. o.

SCHLOSSSCHRAUBE



- ▶ M10x25

W&H Sp. z o. o.

DOPPELGEWINDESCHRAUBE



- ▶ M10x200 A2 Komplett
- ▶ M10x250 A2 Komplett
- ▶ M10x300 A2 Komplett

W&H Sp. z o. o.

FLANSCHMUTTER



- ▶ M10

W&H Sp. z o. o.

RAUTEMUTTER



- ▶ M8

W&H Sp. z o. o.

FARMERSCHRAUBE



- ▶ 4,8x55

W&H Sp. z o. o.

BLECHSCHRAUBE



- ▶ 5,5x25 EPDM

W&H Sp. z o. o.

BLECHSCHRAUBE GELB



- ▶ 8x50, 6x60, 6x100

W&H Sp. z o. o.

VERSCHIEBBARER NUT MIT KUGEL

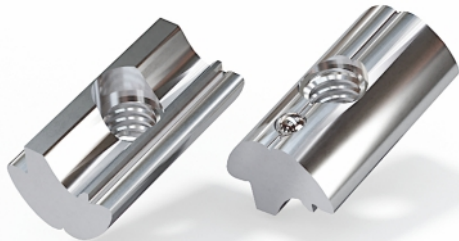

▶ M8

W&H Sp. z o. o.

ERDUNGSPLÄTTCHEN

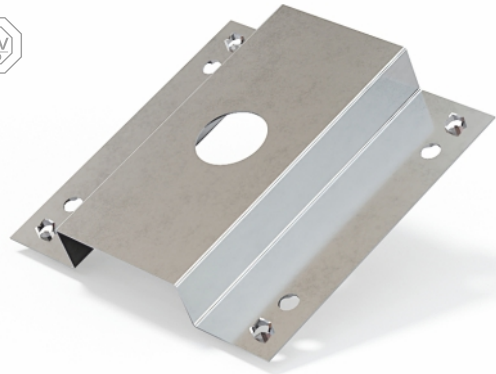

▶ inox

W&H Sp. z o. o.

MITTLERE KLEMME

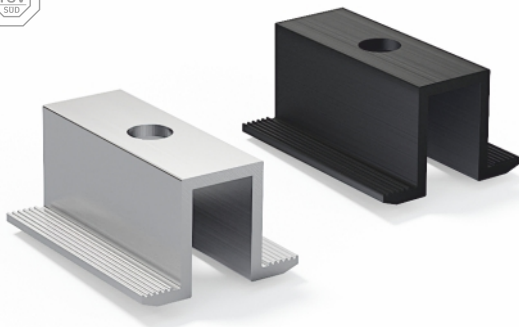

▶ silbern/schwarz

W&H Sp. z o. o.

ENDKLEMME

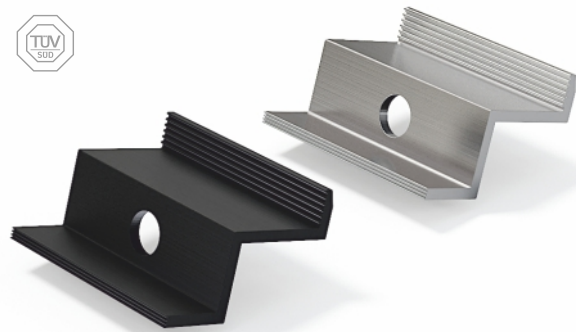

▶ 30, 32, 35, 40

▶ silbern/schwarz

W&H Sp. z o. o.

MONTAGEADAPTER



▶ aus Stahl: 30x5
▶ aus Aluminium: 30x5, 40x5

W&H Sp. z o. o.

VERBINDER DER MONTAGEPROFILE



▶ 40x40, 80x40

W&H Sp. z o. o.

KAPPE 40X40

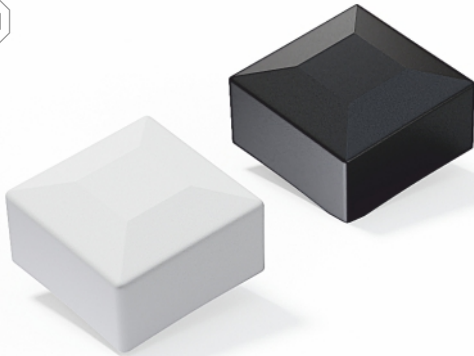

▶ silbern/schwarz

W&H Sp. z o. o.

KAPPE 80X40



▶ silbern/schwarz

W&H Sp. z o. o.

PFAHLRAMMENAUFSATZ



▶ schwarz

W&H Sp. z o. o.

TRAPEZBRÜCKE T40

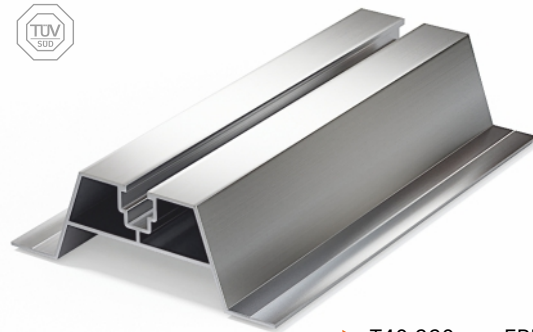

- ▶ T40 330mm EPDM
- ▶ T40 400mm EPDM
- ▶ T40 470mm EPDM

W&H Sp. z o. o.

TRAPEZBRÜCKE T70



- ▶ T70 330mm EPDM
- ▶ T70 400mm EPDM
- ▶ T70 470mm EPDM

W&H Sp. z o. o.

T70 BRÜCKE FÜR BLECHDACHZIEGEL SCHRÄG

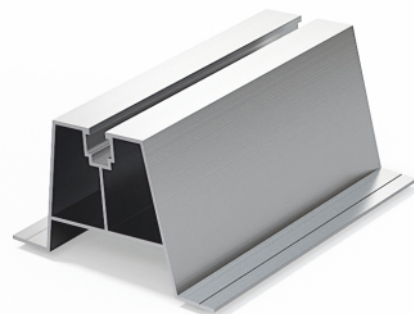

▶ 330mm

W&H Sp. z o. o.

**TRAPEZBRÜCKE
T40 MAGNELIS**



- ▶ T40 330mm EPDM
- ▶ T40 400mm EPDM
- ▶ T40 470mm EPDM

W&H Sp. z o. o.

**TRAPEZBRÜCKE
T70 MAGNELIS**



- ▶ T70 330mm EPDM
- ▶ T70 400mm EPDM
- ▶ T70 470mm EPDM

W&H Sp. z o. o.

**EINSEITIGE BRÜCKE
KLICKSYSTEM**

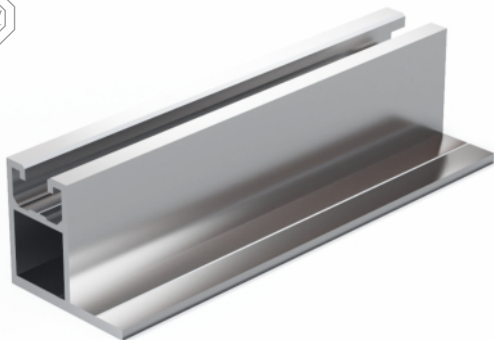

W&H Sp. z o. o.

**DOPPELSEITIGE BRÜCKE
KLICKSYSTEM**

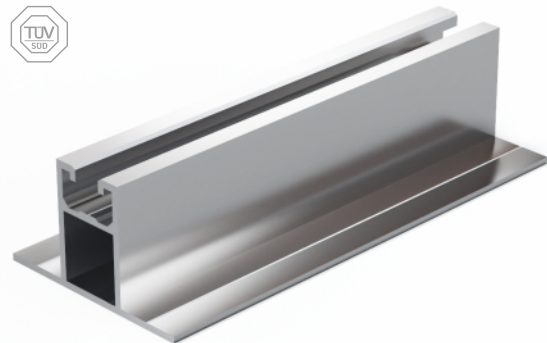

W&H Sp. z o. o.

**ENDKLEMMEN
KLICKSYSTEM**

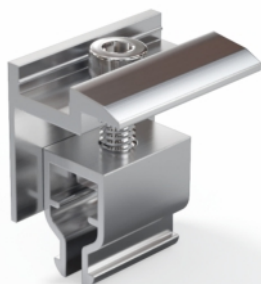

W&H Sp. z o. o.

**MITTELKLEMMEN
KLICKSYSTEM**

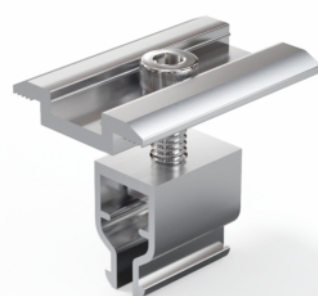

W&H Sp. z o. o.

ALUMINIUMPROFIL FÜR SECHSKANTSCHRAUBE

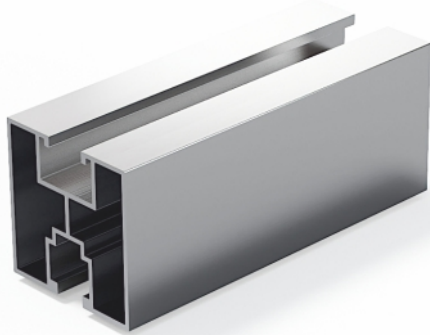

▶ 40X40 Sechskantschraube

W&H Sp. z o. o.

ALUMINIUMPROFIL FÜR HAMMERSCHRAUBE

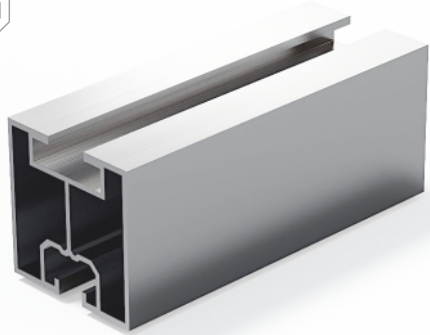

▶ 40X40 Hammerschraube

W&H Sp. z o. o.

„ENGLISCHES“ ALUMINIUMPROFIL



▶ 40X40

W&H Sp. z o. o.

FALZHALTER



▶ UBR

W&H Sp. z o. o.

ABSTANDSHALTER EPDM



W&H Sp. z o. o.

HALTER EINSTELLBAR FÜR BLECHDACHZIEGEL „JANOSIK“



W&H Sp. z o. o.

L HALTER EINSTELLBAR



▶ ULR175

W&H Sp. z o. o.

L HALTERNICHT EINSTELLBAR



▶ ULN175

W&H Sp. z o. o.

S HALTER EINSTELLBAR



▶ USR420, USR450, USR480, USR500
▶ USR520, USR550, USR570, USR600

W&H Sp. z o. o.

S HALTERNICHT EINSTELLBAR



▶ USN460, USN470, USN480, USN500
▶ USN520, USN550, USN560

W&H Sp. z o. o.

T HALTER EINSTELLBAR FÜR BLECHDACHZIEGEL



▶ UDB350, UDB400

W&H Sp. z o. o.

T HALTER EINSTELLBAR FÜR BIBERSCHWANZ



▶ UKR305

W&H Sp. z o. o.

HALTERNICHT EINSTELLBAR FÜR BIBERSCHWANZ



▶ UKN305

W&H Sp. z o. o.

HALTER FÜR BIBERSCHWANZ BREIT



▶ 300mm

W&H Sp. z o. o.

DOPPELT EINSTELLBARER SPARRENHALTER I



▶ 140mm Vario I

W&H Sp. z o. o.

DOPPELT EINSTELLBARER SPARRENHALTER II



▶ 140mm Vario II

W&H Sp. z o. o.

DOPPELT EINSTELLBARER SPARRENHALTER III



▶ 140mm Vario III

W&H Sp. z o. o.

SPARRENHALTER MIT „ENGLISCHEM PROFIL“



▶ 140mm Vario IV

W&H Sp. z o. o.

MONTAGEDREIECK KLEIN



▶ Horizontale Ausrichtung der Module 15° 25°

W&H Sp. z o. o.

MONTAGEDREIECK GROSS



▶ Vertikale Ausrichtung der Module 15° 25°

W&H Sp. z o. o.

MONTAGEDREIECK GROSS EINSTELLBAR



▶ Vertikale Ausrichtung der Module

W&H Sp. z o. o.

MAGNELISDREIECK EINSTELLBAR SÜDEN 15/20°



▶ Horizontale Ausrichtung der Module 15/20°

W&H Sp. z o. o.

MAGNELISDREIECK OST WEST 15°



▶ Horizontale Ausrichtung der Module 15°

W&H Sp. z o. o.

MAGNELISDREIECK MODULAR SÜDEN 15°



▶ Horizontale Ausrichtung der Module 15°

W&H Sp. z o. o.

MONTAGE PLATTE

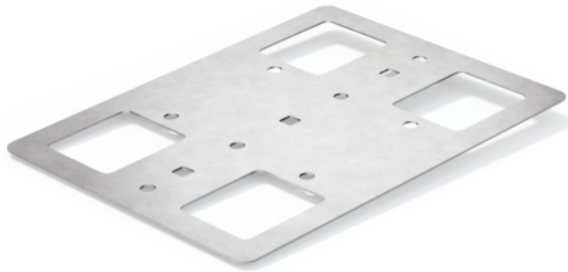

▶ 300x225x1,5mm

W&H Sp. z o. o.

SCHRAUBE MIT DRUCKPLATTE AUF EINER EPDM-UNTERLAGE



▶ fi 80mm

W&H Sp. z o. o.

MONTAGEDREIECK MAGNELIS



▶ Vertikale ausrichtung der Module 15° 25°

W&H Sp. z o. o.

WÄRMEPUMPENSTÄNDER KLEIN



▶ Länge 480, 780 Breite: 430 Höhe: 430

W&H Sp. z o. o.

WÄRMEPUMPENSTÄNDER GROSS



▶ Länge 735, 1200 Breite: 430 Höhe: 430

W&H Sp. z o. o.

STÄNDER FÜR WECHSELRICHTER



▶ Breite: 1485, 2000 Höhe: 3000



📍 **W&H Sp. z o.o.**

ul. Kościuszki 49,
44-351 Turza Śląska,
Polen

☎ +48 730 92 92 92

✉ oferta@hetmaniok.pl

[hetmaniok.pl](https://www.hetmaniok.pl)