



MONTÁŽNÍ  
KONSTRUKCE

PRO FOTOVOLTAIKU

KATALOG VÝROBKU | 2024



**ISO 9001**  
**EN ISO 1090**  
**EN ISO 3834 2**

📍 **W&H Sp. z o.o.**

ul. Kościuszki 49,  
44-351 Turza Śląska,  
Polsko

☎ +48 794 730 721

+48 575 530 721

+48 794 930 721

✉ [biuro@hetmaniok.pl](mailto:biuro@hetmaniok.pl)

🖱 [hetmaniok.pl](http://hetmaniok.pl)

# KATALOG VÝROBKŮ

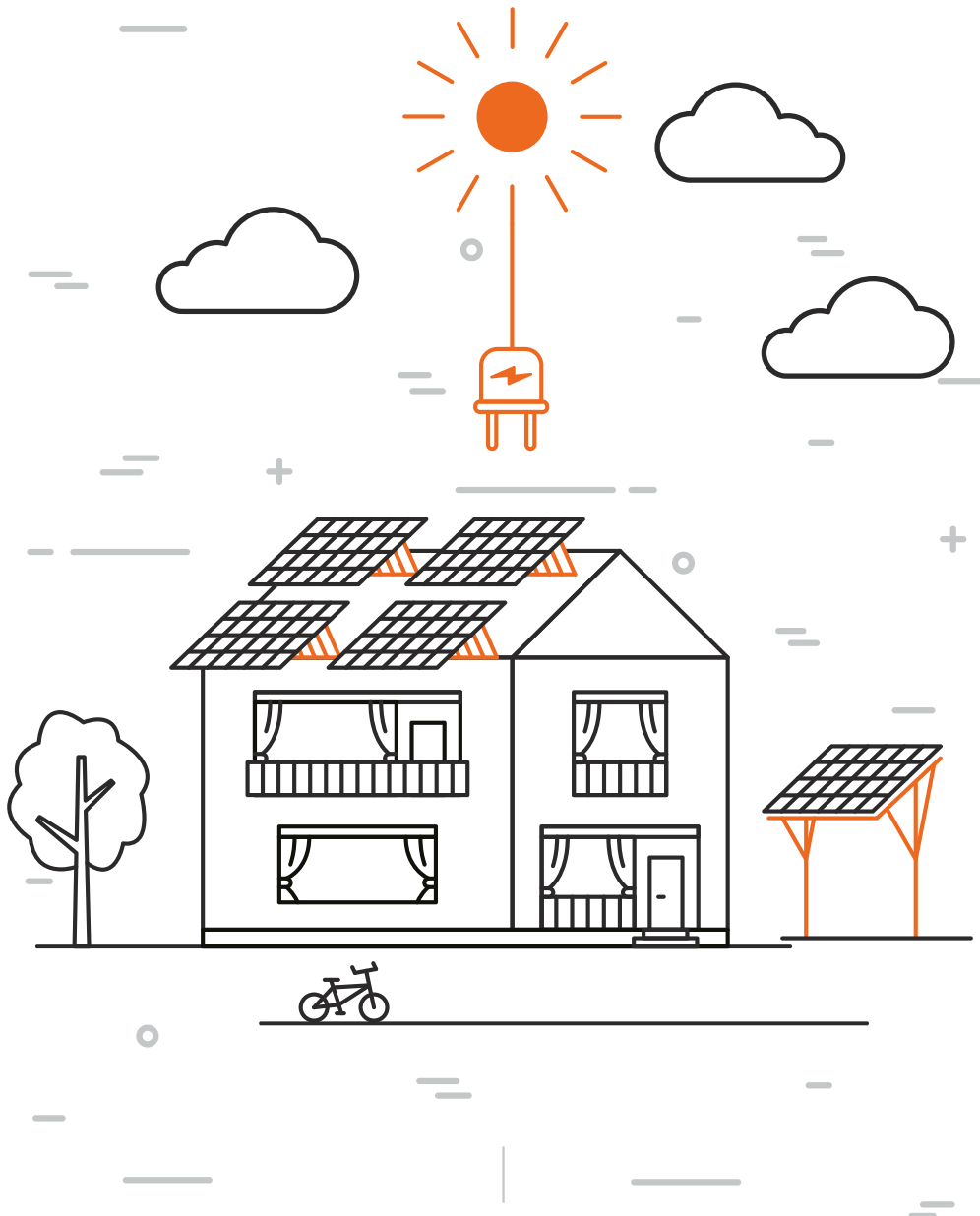

MONTÁŽNÍ KONSTRUKCE  
PRO FOTOVOLTAIKU

W&H Sp. z o. o.

# KONSTRUKCE NA ŠIKMOU STŘECHU

► Počet modulů: od 2  
Certifikát TÜV



**PLECH S DRÁŽKOU**



**TRAPÉZOVÝ PLECH**



**TRAPÉZOVÝ PLECH, KLIK SYSTÉM, VODOROVNÝ**

Střechou, s níž se v Polsku setkáváme nejčastěji, je šikmá střecha. Fotovoltaické panely je možné namontovat i na střechu tohoto typu. Základem takové instalace je odpovídající konstrukce, zejména pak řešení, které umožní efektivní upevnění v závislosti na střešní krytině.



**TRAPÉZOVÝ PLECH, KLIK SYSTÉM, SVISLÝ**



**BITUMENOVÁ STŘEŠNÍ KRYTINA**



**BITUMENOVÁ STŘEŠNÍ KRYTINA, DVOUZÁVIT**



**KERAMICKÁ/BETONOVÁ STŘEŠNÍ KRYTINA**



**PLOCHÁ STŘEŠNÍ KRYTINA**



**PLECHOVÁ STŘEŠNÍ KRYTINA, NASTAVITELNÝ DRŽÁK**



**PLECHOVÁ STŘEŠNÍ KRYTINA „JANOŠÍK“, NASTAVITELNÝ DRŽÁK**



**PLECHOVÁ STŘEŠNÍ KRYTINA, DVOUZÁVIT**

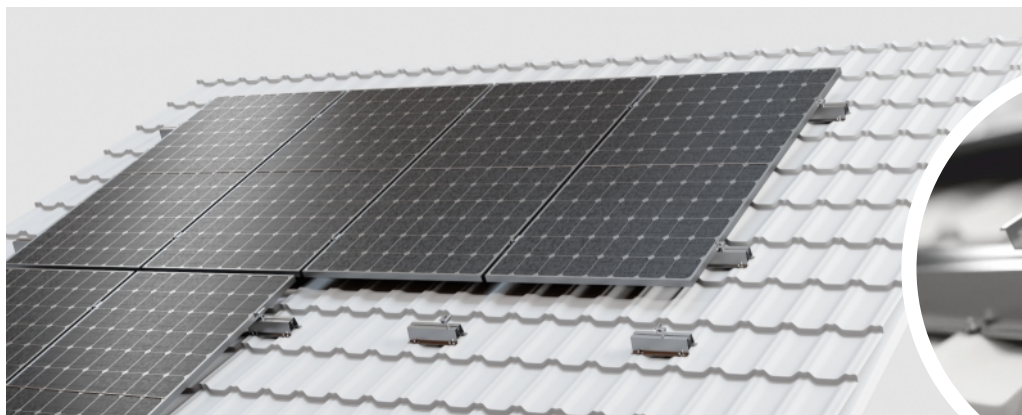

**PLECHOVÁ STŘEŠNÍ KRYTINA, KONSTRUKCE NA MŮSTEK**

W&H Sp. z o. o.

# KONSTRUKCE NA PLOCHOU STŘECHU

▶ Počet modulů: od 1  
▶ Certifikát TÜV



Fotovoltaické instalace montované na plochou střechu vyžadují použití konstrukcí, které umožní dosažení optimálního úhlu dopadu slunečních paprsků vůči fotovoltaickým článkům.

V naší nabídce jsme připravili systémy, které se montují:

- na nízkou a vysokou podpěru,
- na hliníkové trojúhelníky, které umožňují invazivní i neinvazivní upevnění.



**SAMOZÁTĚŽOVÁ KONSTRUKCE  
AERO JIH**

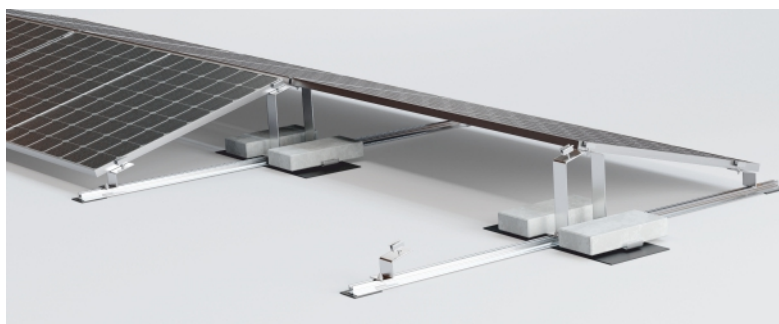

**SAMOZÁTĚŽOVÁ KONSTRUKCE  
AERO VÝCHOD-ZÁPAD**



**ZATÍŽENÁ KONSTRUKCE  
AERO JIH**







**SAMOZÁTĚŽOVÁ ZATÍŽENÁ  
KONSTRUKCE VÝCHOD-ZÁPAD**



**LEPENÁ KONSTRUKCE - VZPĚRY**



**PODPĚRNÁ KONSTRUKCE  
NA LIŠTÁCH AERO**

KONSTRUKCE NA PLOCHOU STŘECHU

# TROJHRAN MAGNELIS

- ▶ Počet modulů: od 1
- ▶ Certifikát TÜV



**JIH 15/20°  
LEPENÁ NA LEPENKU/MEMBRÁNU**



**JIH 15/20°  
DVOUZÁVITOVÝ ŠROUB**

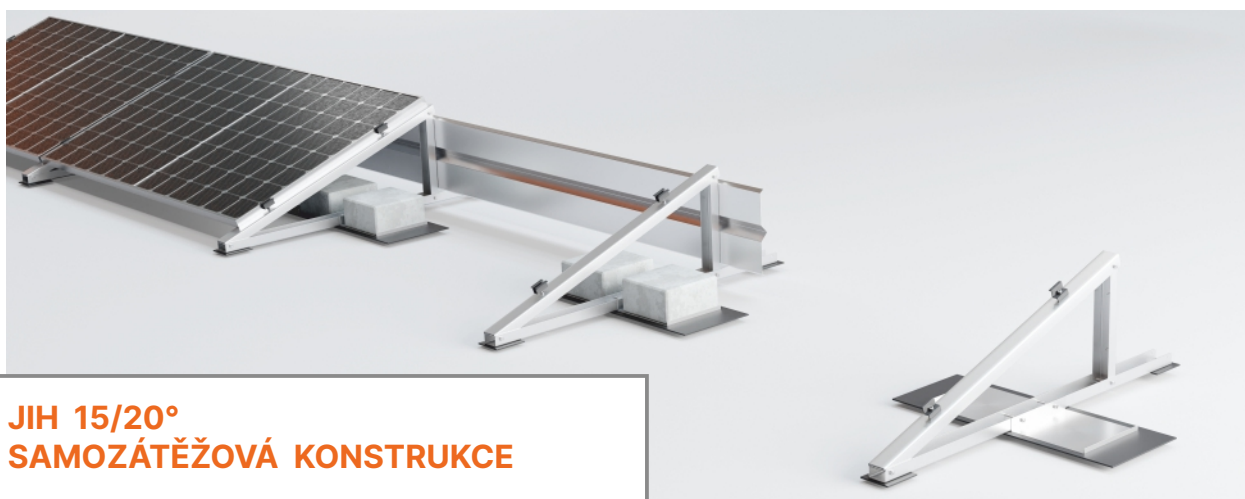

**JIH 15/20°  
SAMOZÁTĚŽOVÁ KONSTRUKCE**



**JIH 15/20°  
NA SENDVIČOVÝ PANEL**



**JIH 15/20° BIFACIAL  
NA SENDVIČOVÝ PANEL**

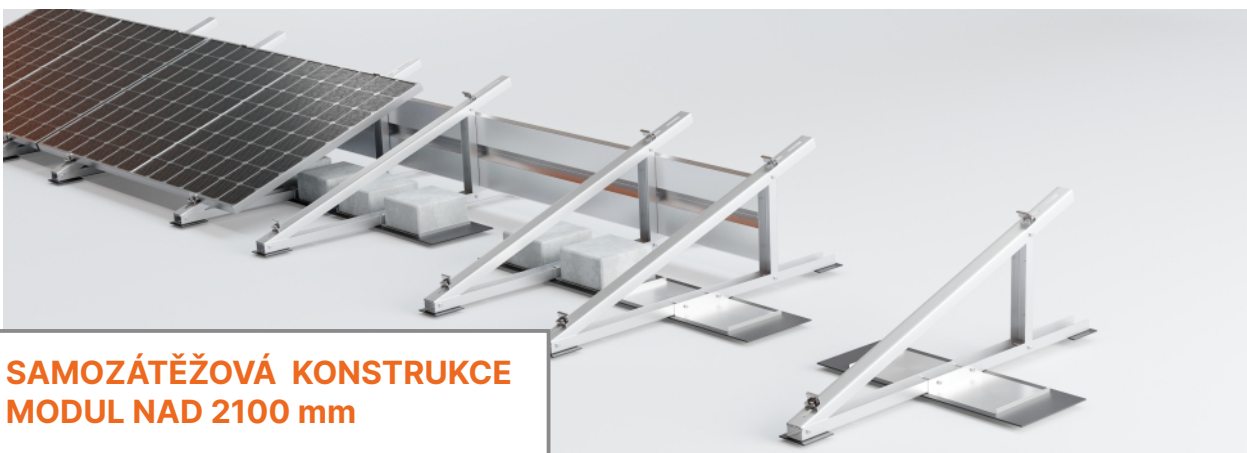

**SAMOZÁTĚŽOVÁ KONSTRUKCE  
MODUL NAD 2100 mm**



**LEPENÁ KONSTRUKCE  
MODUL NAD 2100 mm**



**LEPENÁ KONSTRUKCE  
TROJHRAN MAGNELIS ŠIROKÝ**



**SAMOZÁTĚŽOVÁ KONSTRUKCE  
TROJHRAN MAGNELIS ŠIROKÝ**



**KONSTRUKCE NA LIŠTÁCH AERO  
TROJHRAN MAGNELIS ŠIROKÝ**



**KONSTRUKCE NA LIŠTÁCH AERO  
MODUL NAD 2100 mm**



KONSTRUKCE NA PLOCHOU STŘECHU

# TROJHRAN MAGNELIS

- ▶ Počet modulů: od 2
- ▶ Certifikát TÜV

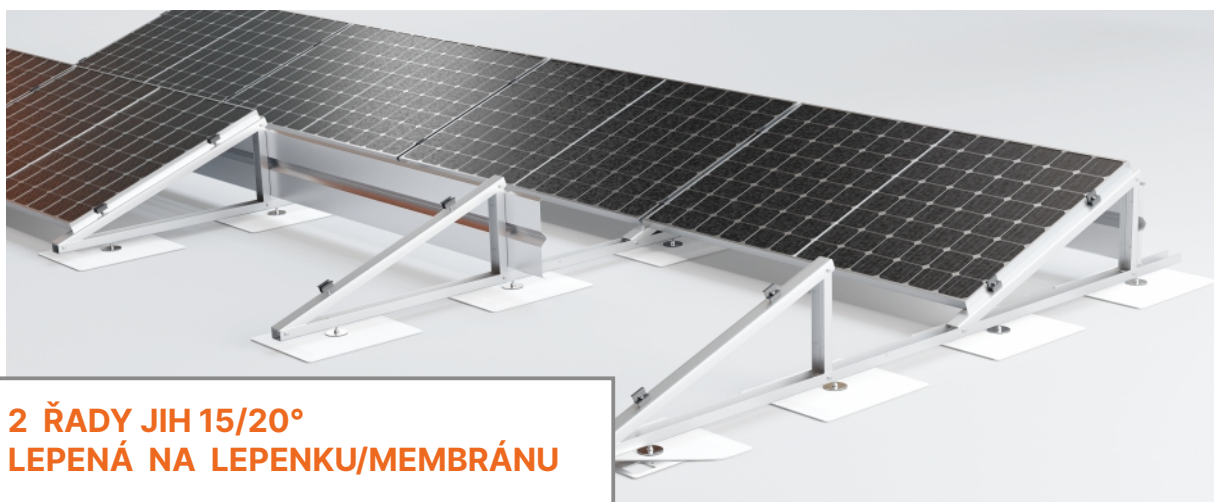

**2 ŘADY JIH 15/20°  
LEPENÁ NA LEPENKU/MEMBRÁNU**



**2 ŘADY JIH 15/20°  
DVOUZÁVITOVÝ ŠROUB**



**2 ŘADY JIH 15/20°  
SAMOZÁTĚŽOVÁ KONSTRUKCE**

KONSTRUKCE NA PLOCHOU STŘECHU

# TROJHRAN MAGNELIS

- ▶ Počet modulů: od 2
- ▶ Certifikát TÜV



**VÝCHOD-ZÁPAD  
LEPENÁ NA LEPENKU/MEMBRÁNU**



**VÝCHOD-ZÁPAD  
DVOUZÁVITOVÝ ŠROUB**

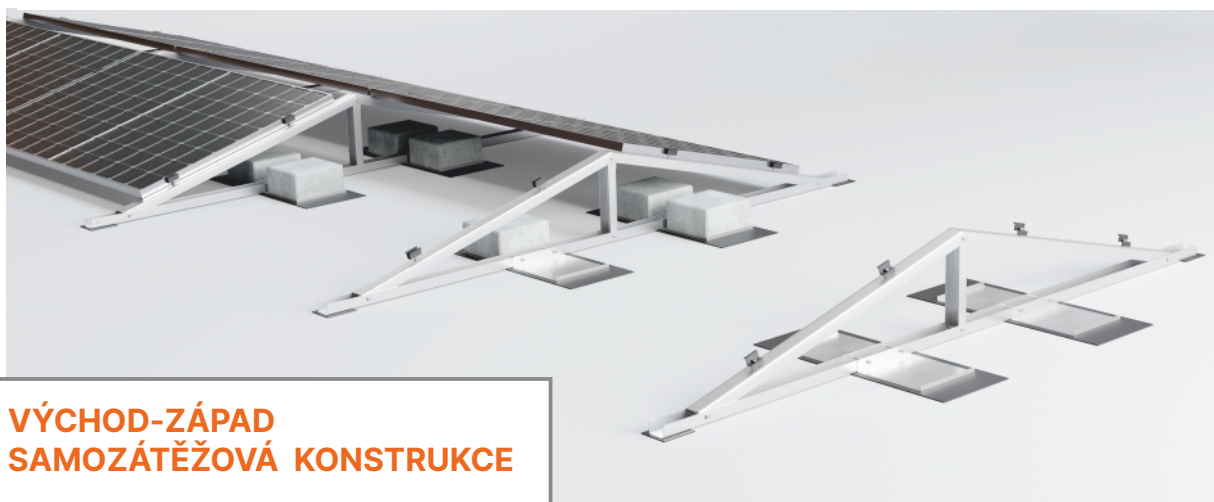

**VÝCHOD-ZÁPAD  
SAMOZÁTĚŽOVÁ KONSTRUKCE**



**KONSTRUKCE ROVNOBĚŽNÁ  
SE STŘECHOU, ŠROUB S PŘÍTLAKEM**



**BALKONOVÁ KONSTRUKCE,  
TROJHRAN MAGNELIS 15°**



**FOTOVOLTAICKÝ PLOT  
1 PANEL SVISLE BIFACIAL**



**FOTOVOLTAICKÝ PLOT  
2 PANELY VODOROVNĚ BIFACIAL**

**VOLNĚ STOJÍCÍ  
KONSTRUKCE**

# NA DVOU PODPĚRÁCH



**OCELOVÁ  
KONSTRUKCE/MAGNELIS**



**2 PANELY  
SVISLE**

- ▶ Počet modulů: od 2
- ▶ Certifikát TÜV



**4 PANELY  
VODOROVNĚ**

- ▶ Počet modulů: od 4
- ▶ Certifikát TÜV



Volně stojící konstrukce vyžadují vzhledem k usazení na zemi zvláštní propracování všech součástí. Podle potřeby jsou k dispozici konstrukce s jednou i s dvěma podpěrami.



**OCELOVÁ  
KONSTRUKCE/HLINÍK**



**2 PANELY  
SVISLE**

- ▶ Počet modulů: od 2
- ▶ Certifikát TÜV



**3 PANELY  
VODOROVNĚ**

- ▶ Počet modulů: od 3
- ▶ Certifikát TÜV



**4 PANELY  
VODOROVNĚ**

- ▶ Počet modulů: od 4
- ▶ Certifikát TÜV



**5 PANELŮ  
VODOROVNĚ**

- ▶ Počet modulů: od 5
- ▶ Certifikát TÜV

Volně stojící konstrukce vyžadují vzhledem k usazení na zemi zvláštní propracování všech součástí. Podle potřeby jsou k dispozici konstrukce s jednou i s dvěma podpěrami.



**OCELOVÁ  
KONSTRUKCE/MAGNELIS**



**2 PANELY  
SVISLE  
BIFACIAL**

- ▶ Počet modulů: od 2
- ▶ Certifikát TÜV



**3 PANELY  
VODOROVNĚ**

- ▶ Počet modulů: od 3
- ▶ Certifikát TÜV



**3 PANELY  
VODOROVNĚ  
BIFACIAL**

- ▶ Počet modulů: od 3
- ▶ Certifikát TÜV



**4 PANELY  
VODOROVNĚ  
BIFACIAL**

- ▶ Počet modulů: od 4
- ▶ Certifikát TÜV

**VOLNĚ STOJÍCÍ  
KONSTRUKCE**

# S JEDNOU PODPĚROU



**OCELOVÁ  
KONSTRUKCE/HLINÍK**



**2 PANELY  
SVISLE**

- ▶ Počet modulů: od 2
- ▶ Certifikát TÜV



**3 PANELY  
VODOROVNĚ**

- ▶ Počet modulů: od 3
- ▶ Certifikát TÜV

**VOLNĚ STOJÍCÍ  
KONSTRUKCE**

# CARPORT



**HLINÍKOVÁ  
KONSTRUKCE**

pro moduly > 25 kg

**OCELOVÁ  
KONSTRUKCE**



HLINÍKOVÁ  
NEBO OCELOVÁ  
KONSTRUKCE



MODULOVÝ  
SYSTÉM  
POJOVÁNÍ



LIBOVOLNÁ  
BARVA Z PALETY  
RAL

V naší nabídce naleznete hliníkové a ocelové carporty se stáním pro jedno nebo dvě vozidla s možností modulového spojování.

Velikost carportu s jedním stáním je 2,5 m na šířku (dle aktuálních požadavků).

Je možné provést carport podle individuálních požadavků zákazníka včetně nátěru libovolnou barvou z palety RAL.

# SOUČÁSTI MONTÁŽNÍCH KONSTRUKCÍ

Jako výrobce montážních konstrukcí nabízíme osvědčená řešení pro každý typ střechy s libovolným typem střešní krytiny. Sázíme na kvalitu a trvanlivost všech konstrukčních součástí.

W&H Sp. z o. o.

## ŠROUB IMBUS



- ▶ M8x20
- ▶ M8x25
- ▶ M8x30
- ▶ M8x35

W&H Sp. z o. o.

## ŠROUB S ŠESTIHRANNOU HLAVOU



- ▶ M10x25

W&H Sp. z o. o.

## ŠROUB S Kladívkovou HLAVOU



- ▶ M10x25
- ▶ M10x30

W&H Sp. z o. o.

## VRATOVÝ ŠROUB



- ▶ M10x25

W&H Sp. z o. o.

### DVOUZÁVITOVÝ ŠROUB



- ▶ M10x200 A2 kompletní set dílů
- ▶ M10x250 A2 kompletní set dílů
- ▶ M10x300 A2 kompletní set dílů

W&H Sp. z o. o.

### LÍMCOVÁ MATICE



▶ M10

W&H Sp. z o. o.

### T-MATICE RHOMBUS



▶ M8

W&H Sp. z o. o.

### FARMÁŘSKÝ VRUT



▶ 4,8x55

W&H Sp. z o. o.

### ŠROUB DO PLECHU



▶ 5,5x25 EPDM

W&H Sp. z o. o.

### MOSAZENÝ ŠROUB



▶ 8x50, 6x60, 6x100

W&H Sp. z o. o.

### POSUVNÁ DRÁŽKA S KULIČKOU



► M8

W&H Sp. z o. o.

### ZEMNÍČÍ DESKA



► inox

W&H Sp. z o. o.

### STŘEDOVÁ SVORKA



► stříbrná/černá

W&H Sp. z o. o.

### KONCOVÁ SVORKA

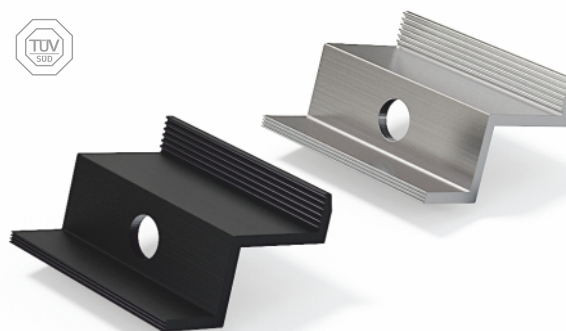

► 30, 32, 35, 40  
► stříbrná/černá

W&H Sp. z o. o.

### MONTÁŽNÍ ADAPTÉR



► ocelový: 30x5  
► hliníkový: 30x5, 40x5

W&H Sp. z o. o.

### SPOJKA MONTÁŽNÍCH PROFILŮ



► 40x40, 80x40

W&H Sp. z o. o.

### NÁSTAVEC 40X40

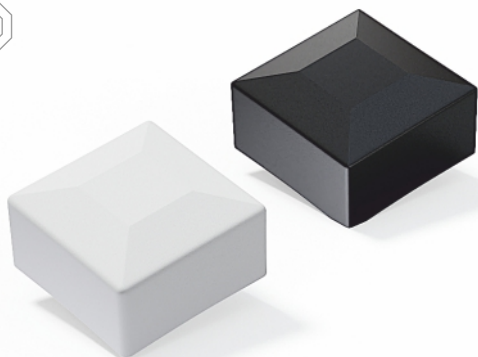

▶ stříbrná/černá

W&H Sp. z o. o.

### NÁSTAVEC 80X40



▶ stříbrná/černá

W&H Sp. z o. o.

### NÁSTAVEC OD BERANIDLA



▶ černá

W&H Sp. z o. o.

### TRAPÉZOVÝ MŮSTEK T40

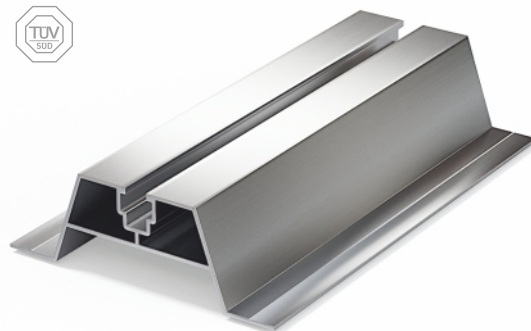

- ▶ T40 330mm s EPDM
- ▶ T40 400mm s EPDM
- ▶ T40 470mm s EPDM

W&H Sp. z o. o.

### TRAPÉZOVÝ MŮSTEK T70



- ▶ T70 330mm s EPDM
- ▶ T70 400mm s EPDM
- ▶ T70 470mm s EPDM

W&H Sp. z o. o.

### ŠIKMÝ MŮSTEK PRO PLECHOVOU KRYTINU



▶ 330mm



W&H Sp. z o. o.

### TRAPÉZOVÝ MŮSTEK T40 MAGNELIS



- ▶ T40 330mm s EPDM
- ▶ T40 400mm s EPDM
- ▶ T40 470mm s EPDM

W&H Sp. z o. o.

### TRAPÉZOVÝ MŮSTEK T70 MAGNELIS



- ▶ T70 330mm s EPDM
- ▶ T70 400mm s EPDM
- ▶ T70 470mm s EPDM

W&H Sp. z o. o.

### JEDNOSTRANNÝ MŮSTEK, KLIK SYSTÉM

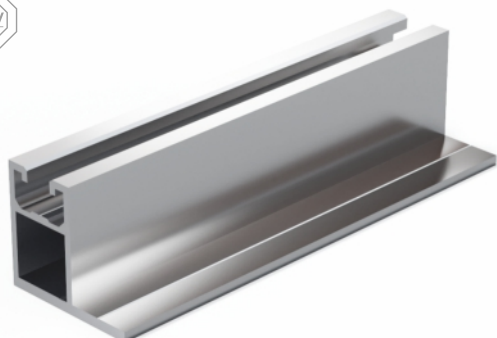

W&H Sp. z o. o.

### OBOUSTRANNÝ MŮSTEK, KLIK SYSTÉM

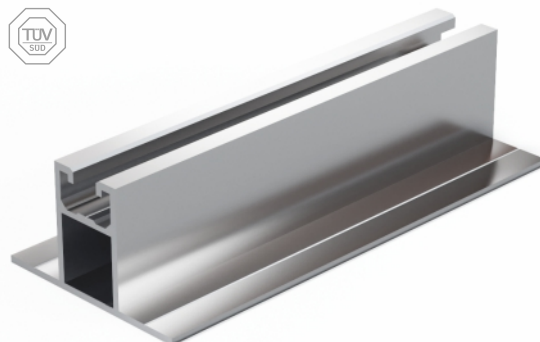

W&H Sp. z o. o.

### KONCOVÉ SVORKY PRO KLIK SYSTÉM

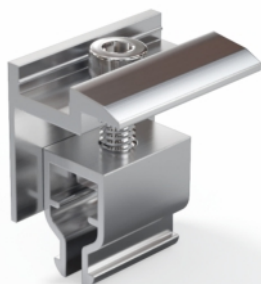

W&H Sp. z o. o.

### STŘEDOVÉ SVORKY PRO KLIK SYSTÉM

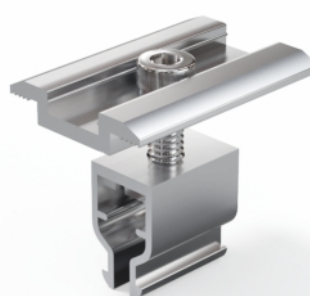

W&H Sp. z o. o.

### HLINÍKOVÝ PROFIL PRO ŠROUB S ŠESTIHRANNOU HLAVOU

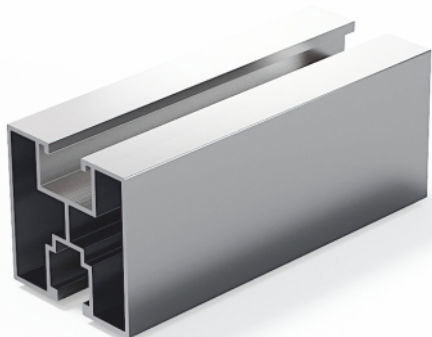

▶ 40X40 Šroub s šestihrannou hlavou

W&H Sp. z o. o.

### HLINÍKOVÝ PROFIL PRO ŠROUB S Kladívkovou HLAVOU

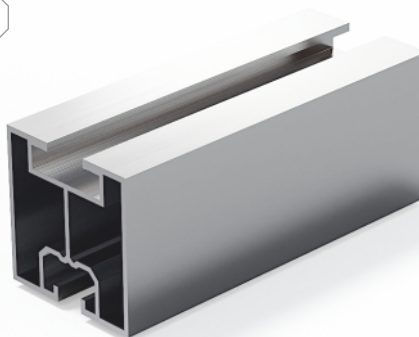

▶ 40X40 Šroub s kladívkovou hlavou

W&H Sp. z o. o.

### HLINÍKOVÝ PROFIL „ANGLICKÝ“

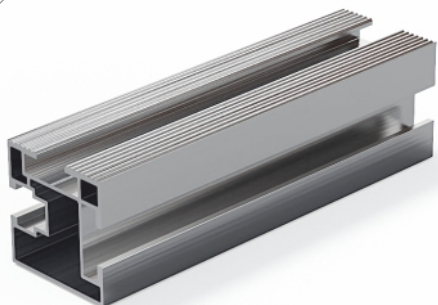

▶ 40X40

W&H Sp. z o. o.

### DRŽÁK S DRÁŽKOU



▶ UBR

W&H Sp. z o. o.

### DISTANČNÍ KUS EPDM



W&H Sp. z o. o.

### NASTAVITELNÝ DRŽÁK PRO PLECHOVOU STŘEŠNÍ KRYTINU „JÁNOŠÍK“

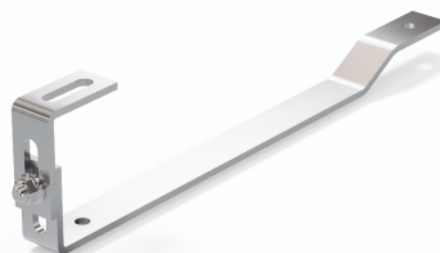

W&H Sp. z o. o.

### NASTAVITELNÝ DRŽÁK L



▶ ULR175

W&H Sp. z o. o.

### DRŽÁK BEZ NASTAVENÍ L



▶ ULN175

W&H Sp. z o. o.

### NASTAVITELNÝ DRŽÁK S



▶ USR420, USR450, USR480, USR500  
▶ USR520, USR550, USR570, USR600

W&H Sp. z o. o.

### DRŽÁK BEZ NASTAVENÍ S



▶ USN460, USN470, USN480, USN500  
▶ USN520, USN550, USN560

W&H Sp. z o. o.

### NASTAVITELNÝ DRŽÁK T NA PLECHOVOU STŘEŠNÍ KRYTINU



▶ UDB350, UDB400

W&H Sp. z o. o.

### NASTAVITELNÝ DRŽÁK T NA PLOCHOU STŘEŠNÍ KRYTINU



▶ UKR305

W&H Sp. z o. o.

**DRŽÁK NA PLOCHOU  
STŘEŠNÍ KRYTINU BEZ NASTAVENÍ**



▶ UKN305

W&H Sp. z o. o.

**DRŽÁK NA PLOCHOU  
STŘEŠNÍ KRYTINU ŠIROKÝ**



▶ 300mm

W&H Sp. z o. o.

**DRŽÁK NA KROKEV  
S DVOJITÝM NASTAVENÍM I**



▶ 140mm Vario I

W&H Sp. z o. o.

**DRŽÁK NA KROKEV  
S DVOJITÝM NASTAVENÍM II**



▶ 140mm Vario II

W&H Sp. z o. o.

**DRŽÁK NA KROKEV  
S DVOJITÝM NASTAVENÍM III**



▶ 140mm Vario III

W&H Sp. z o. o.

**DRŽÁK NA KROKEV  
S „ANGLICKÝM“ PROFILEM**



▶ 140mm Vario IV

W&H Sp. z o. o.

**MONTÁŽNÍ TROJHRAN MALÝ**



▶ Horizontální orientace modulů 15° 25°

W&H Sp. z o. o.

**MONTÁŽNÍ TROJHRAN VELKÝ**



▶ Vertikální orientace modulů 15° 25°

W&H Sp. z o. o.

**MONTÁŽNÍ TROJHRAN VELKÝ NASTAVITELNÝ**



▶ Vertikální orientace modulů

W&H Sp. z o. o.

**TROJHRAN MAGNELIS NASTAVITELNÝ, JIH 15/20°**



▶ Horizontální orientace modulů 15° 20°

W&H Sp. z o. o.

**TROJHRAN MAGNELIS VÝCHOD-ZÁPAD 15°**



▶ Horizontální orientace modulů 15°

W&H Sp. z o. o.

**TROJHRAN MAGNELIS MODULOVÝ, JIH 15°**



▶ Horizontální orientace modulů 15°

W&H Sp. z o. o.

### MONTÁŽNÍ DESKA

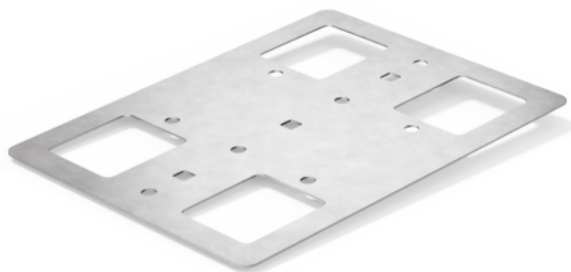

▶ 300x225x1,5mm

W&H Sp. z o. o.

### ŠROUB S PŘÍTLAČNOU DESKOU NA PODLOŽCE Z EPDM



▶ fi 80mm

W&H Sp. z o. o.

### MONTÁŽNÍ TROJHRAN MAGNELIS ŠÍROKÝ



▶ Horizontální orientace modulů 15° 25°

W&H Sp. z o. o.

### STOJAN NA TEPELNÉ ČERPADLO MALÝ



▶ délka: 480, 780      šířka: 430      výška: 430

W&H Sp. z o. o.

### STOJAN NA TEPELNÉ ČERPADLO VELKÝ



▶ délka: 735, 1200      šířka: 430      výška: 430

W&H Sp. z o. o.

### STOJAN NA STRÍDAČ



▶ šířka: 1485, 2000      výška: 3000





📍 **W&H Sp. z o.o.**

ul. Kościuszki 49,  
44-351 Turza Śląska,  
Polsko

☎ +48 730 92 92 92

✉ oferta@hetmaniok.pl

**hetmaniok.pl**

